



REQUEST FOR BID

BOONE COUNTY PURCHASING
613 East Ash Street, Room 110
Columbia, MO 65201

Melinda Bobbitt, CPPO, CPPB
Director of Purchasing
Phone: (573) 886-4391
Facsimile: (573) 886-4390
mbobbitt@boonecountymo.org

BID DATA

INFORMATION

Bid Number: 30-19MAY16

Bid Title: Office Furniture for the Emergency Communication Center

SUBMISSION INFORMATION

Due Date and Time: Thursday, May 19, 2016 at 1:00 p.m. Central Time

Location: Boone County Purchasing Department
Boone County Annex Building
613 East Ash Street, Room 110
Columbia, MO 65201

OPENING INFORMATION

Date and Time: Thursday, May 19, 2016 at 1:30 p.m. Central Time

Location: Boone County Commission Chambers
Boone County Government Center
801 East Walnut Street
Columbia, MO 65201

BID CONTENTS

1. Introduction and General Conditions of Bidding
2. Contract Conditions and Requirements
3. Primary Specifications
4. Response Presentation and Review
5. Response Form
6. Attachments:
 - Teknion Expansion Desking
 - Director's office specifications based off OFS Denali
 - Furniture Bid Specifications
 - Statement of Bidder's Qualifications and Prior Experience
 - Compliance with House Bill 1549, Work Authorization Certification, & Certification of Individual Bidder and Affidavit
 - Certification Regarding Debarment

Affidavit for Compliance with Prevailing Wage
Affidavit of Compliance with OSHA Training
Standard Terms and Conditions
No Bid Response Form
State Prevailing Wage Order No. 22

INTRODUCTION AND GENERAL CONDITIONS OF BIDDING

- 1.1. INVITATION - The County of Boone, through its Purchasing Department, invites responses, which offer to provide the goods and/or services identified on the title page and described in greater detail in the following Sections of this Request for Bid for the furnishing, delivery and installation of furniture for the Emergency Communications Center (ECC).
- 1.2. DEFINITIONS
 - 1.2.1. County - This term refers to the County of Boone, a duly organized public entity. It may also be used as a pronoun for various subsets of the County organization, including, as the context will indicate:
 - 1.2.1.1. Purchasing - The Purchasing Department, including its Purchasing Director and staff.
 - 1.2.1.2. Department(s) or Office(s) - The County Department(s) or Office(s) for which this Bid is prepared, and which will be the end user(s) of the goods and/or services sought.
 - 1.2.1.3. Designee or Project Manager - The County employee(s) assigned as your primary contact(s) for interaction regarding Contract performance.
 - 1.2.2. Bidder / Contractor / Supplier - These terms refer generally to businesses having some sort of relationship to or with us. The term may apply differently to different classes of entities, as the context will indicate.
 - 1.2.2.1. Bidder - Any business entity submitting a response to this Bid. Suppliers, which may be invited to respond, or which express interest in this bid, but which do not submit a response, have no obligations with respect to the bid requirements.
 - 1.2.2.2. Contractor - The Bidder whose response to this bid is found by Purchasing to meet the best interests of the County. The Contractor will be selected for award, and will enter into a Contract for provision of the goods and/or services described in the Bid.
 - 1.2.2.3. Supplier - All business(s) entities which may provide the subject goods and/or services.
 - 1.2.3. Bid - This entire document, including attachments. A Bid may be used to solicit various kinds of information. The kind of information this Bid seeks is indicated by the title appearing at the top of the first page. A "Request for Bid" is used when the need is well defined. A "Request for Proposal" is used when the County will consider solutions, which may vary significantly from each other or from the County's initial expectations.
 - 1.2.4. Response - The written, sealed document submitted according to the Bid instructions.
- 1.3. BID CLARIFICATION - Questions regarding this Bid should be directed in writing, by e-mail or fax, to the Purchasing Department. Answers, citing the questions asked but not identifying the questioner, will be distributed simultaneously to all known prospective Bidders in the form of an addendum. We strongly suggest that you check for any addenda a minimum of forty-eight (48) hours in advance of the bid deadline. Bids,

addendums, bid tabulations and bid awards are posted on our web site at: www.showmeboone.com *Note: written requirements in the Bid or its Amendments are binding, but any oral communications between County and Bidder are not.*

1.3.1. Bidder Responsibility - The Bidder is expected to be thoroughly familiar with all specifications and requirements of this Bid. Bidder's failure or omission to examine any relevant form, article, site or document will not relieve them from any obligation regarding this Bid. By submitting a Response, Bidder is presumed to concur with all terms, conditions and specifications of this Bid.

1.3.2. Bid Addendum - If it becomes evident that this Bid must be amended, the Purchasing Department will issue a formal written Addendum to all known prospective Bidders. If necessary, a new due date will be established.

1.4. **AWARD** - Award will be made to the Bidder(s) whose offer(s) provide the greatest value to the County from the standpoint of suitability to purpose, quality, service, previous experience, price, lifecycle cost, ability to deliver, or for any other reason deemed by Purchasing to be in the best interest of the County. Thus, the result will not be determined by price alone. The County will be seeking the least costly outcome that meets the County needs as interpreted by the County.

1.5. **PROPOSED SOLICITATION AND AWARD SCHEDULE**

Release of Request for Bid	April 28, 2016
Deadline for Submitting Questions	May 16, 2016, 2:00 p.m.
Bid Responses Due	May 19, 1:00 p.m.
Contract Award	June 2, 2016
Notice to Proceed	On or about June 9, 2016
Project Completion	August 1, 2016

1.6. **CONTRACT EXECUTION** - This Bid and the Contractor's Response will be made part of any resultant Contract and will be incorporated in the Contract as set forth, verbatim.

1.6.1. Precedence - In the event of contradictions or conflicts between the provisions of the documents comprising this Contract, they will be resolved by giving precedence in the following order:

- a. the provisions of the Contract (as it may be amended);
- b. the provisions of the Bid;
- c. the provisions of the Bidder's Response.

1.7. **COMPLIANCE WITH STANDARD TERMS AND CONDITIONS** - Bidder agrees to be bound by the County's standard "boilerplate" terms and conditions for Contracts, a sample of which is attached to this Bid.

1.8. **CONTRACT DOCUMENTS** - The successful bidder(s) shall be obligated to enter into a written contract with the County within thirty (30) days of award on contract. If bidders desire to contract under their own written agreement, any such proposed agreement shall be submitted with their bid. County reserves the right to modify any proposed form agreement or withdraw its award to a successful bidder if any proposed agreement

contains terms and conditions inconsistent with its bid or are unacceptable to County legal counsel.

- 1.9. PRICING – All prices shall be as indicated on the Response Form. The County shall not pay nor be liable for any other additional costs, including but not limited to: taxes, packing, handling, shipping and freight, insurance, interest, penalties, termination payments, attorney fees, liquidated damages, etc.

2. CONTRACT CONDITIONS AND REQUIREMENTS

2.1. INSURANCE

- 2.1.1. Insurance Requirements - The Contractor shall not commence work under this contract until they have obtained all insurance required under this paragraph and the Certificate of Insurance has been approved by the County, nor shall the Contractor allow any subcontractor to commence work on their subcontract until all similar insurance required of subcontractor has been so obtained and approved. All policies shall be in amounts, form and companies satisfactory to the County which must carry an A-6 or better rating as listed in the A.M. Best or equivalent rating guide. Insurance limits indicated below may be lowered at the discretion of the County.
- 2.1.2. Employers Liability and Workers Compensation Insurance - The Contractor shall take out and maintain during the life of this contract, **Employers Liability and Workers Compensation Insurance** for all of its employees employed at the site of work, and in case any work is sublet, the Contractor shall require the subcontractor similarly to provide Workers Compensation Insurance for all of the latter's employees unless such employees are covered by the protection afforded by the Contractor. Workers Compensation coverage shall meet Missouri statutory limits. Employers Liability limits shall be \$500,000.00 each employee, \$500,000.00 each accident, and \$500,000.00 policy limit. In case any class of employees engaged in hazardous work under this Contract at the site of the work is not protected under the Workers Compensation Statute, the Contractor shall provide and shall cause each subcontractor to provide Employers Liability Insurance for the protection of their employees not otherwise protected.
- 2.1.3. Commercial General Liability Insurance - The Contractor shall take out and maintain during the life of this contract, such commercial general liability insurance as shall protect it and any subcontractor performing work covered by this contract, from claims for damages for personal & advertising injury, bodily injury including accidental death, as well as from claims for property damages, which may arise from operations under this contract, whether such operations be by themselves or for any subcontractor or by anyone directly or indirectly employed by them. The amounts of insurance shall be not less than \$1,000,000.00 per occurrence/\$2,000,000 aggregate covering both bodily injury and property damage, including accidental death. If the Contract involves any underground/digging operations, the general liability certificate shall include X, C, and U (Explosion, Collapse, and Underground) coverage. If providing Commercial General Liability Insurance, then the Proof of Coverage of Insurance shall also be included.

- 2.1.3.1. Contractor may satisfy the minimum liability limits required for Commercial General Liability or Business Auto Liability under an Umbrella or Excess Liability policy. There is no minimum per occurrence limit of liability under the umbrella or Excess Liability; however, the Annual Aggregate limit shall not be less than the highest "Each Occurrence" limit for either Commercial General Liability or Business Auto Liability. Contractor agrees to endorse the County as an Additional Insured on the umbrella or Excess Liability, unless the Certificate of Insurance state the Umbrella or Excess Liability provides coverage on a "Follow-Form" basis.
- 2.1.4. Business Automobile Liability – The Contractor shall maintain during the life of this contract, automobile liability insurance in the amount of not less than \$1,000,000.00 combined single limit for any one occurrence, covering both bodily injury, including accidental death, and property damage, to protect themselves from any and all claims arising from the use of the Contractor's own automobiles, teams and trucks; hired automobiles, teams and trucks; non-owned and both on and off the site of work.
- 2.1.5. Subcontractors - Contractor shall cause each Subcontractor to purchase and maintain insurance of the types and amounts specified herein. Limits of such coverage may be reduced only upon written agreement of County. Contractor shall provide to County copies of certificates of insurance evidencing coverage for each Subcontractor. Subcontractors' commercial general liability and business automobile liability insurance shall name County as Additional Insured and have the Waiver of Subrogation endorsements added.
- 2.1.6. Proof of Carriage of Insurance - The Contractor shall furnish the County with Certificate(s) of Insurance which name the County as additional insured in an amount as required in this contract, contain a description of the project or work to be performed and provided for Commercial General Liability, Business Auto Liability, and Umbrella or Excess Liability (not on Workers Compensation). The Certificate of Insurance shall provide that there will be no cancellation, non-renewal or reduction of coverage without 30 days prior written notice to the County. In addition, such insurance shall be on an occurrence basis and shall remain in effect until such time as the County has made final acceptance of the services provided.
- 2.2. INDEMNITY AGREEMENT - To the fullest extent permitted by law, Contractor shall indemnify, hold harmless and defend the County, its directors, officers, agents, and employees from and against all claims, damages, losses and expenses (including but not limited to attorney's fees) arising by reason of any act or failure to act, negligent or otherwise, of Contractor, of any subcontractor (meaning anyone, including but not limited to consultants having a contract with contractor or a subcontract for part of the services), of anyone directly or indirectly employed by contractor or by any subcontractor, or of anyone for whose acts the contractor or its subcontractor may be liable, in connection with providing these services. This provision does not, however, require contractor to indemnify, hold harmless, or defend the County of Boone from its own negligence.
- 2.2.1. Failure to maintain the required insurance in force may be cause for contract termination. In the event the Agency/Service fails to maintain and keep in force the

required insurance or to obtain coverage from its subcontractors, the County shall have the right to cancel and terminate the contract without notice.

- 2.3. **CRIMINAL BACKGROUND CHECK** - Boone County reserves the right to approve individuals who will be working on this project. If requested, individual employees will be expected to execute appropriate releases to authorize criminal background checks which will be performed by the County. Any person who refuses to execute such a release or who does not successfully pass the criminal background check, in the sole judgment of Boone County, may not be permitted to work on the project.
- 2.4. **OVERHEAD LINE PROTECTION** - The Contractor is aware of the provisions of the Overhead Power Line Safety Act, 319.075 to 319.090 RSMo, and agrees to comply with the provisions thereof. Contractor understands that it is their duty to notify any utility operating high voltage overhead lines and make appropriate arrangements with said utility if the performance of contract would cause any activity within ten feet of any high voltage overhead line. To the fullest extent permitted by law, Contractor shall indemnify, hold harmless and defend the County, its directors, officers, agents, and employees from and against all claims, damages, losses and expenses (including but not limited to attorney's fees) arising by reason of any act or failure to act, negligent or otherwise, of Contractor, of any subcontractor (meaning anyone, including but not limited to consultants having a contract with Contractor or a subcontract for part of the services), of anyone directly or indirectly employed by Contractor or by any subcontractor, or of anyone for whose acts the Contractor or its subcontractor may be liable, in connection with any claims arising under the Overhead Power Line Safety Act. Contractor expressly waives any action for contribution against the County on behalf of the Contractor, any subcontractor (meaning anyone, including but not limited to consultants having a contract with Contractor or a subcontract for part of the services), anyone directly or indirectly employed by Contractor or by any subcontractor, or of anyone for whose acts the Contractor or its subcontractor may be liable, and agrees to provide a copy of this waiver to any party affected by this provision.
- 2.5. **OSHA PROGRAM REQUIREMENTS** – The Contractor is familiar with the requirements of 292.675 RSMo. The Contractor shall provide a ten-hour Occupational Safety and Health Administration (OSHA) construction safety program for their on-site employees, subcontractors or others acting on behalf of Contractor on-site which meets the requirements of 292.675 RSMo.
 - 2.5.1. The Contractor and each subcontractor shall keep accurate records of those employees who are working on-site and a record of each such employee's completion of the OSHA program, **and certify compliance by affidavit at the conclusion of the project.**
 - 2.5.2. The Contractor shall forfeit as a penalty to the County the sum of Two Thousand Five Hundred Dollars (\$2,500.00) plus One Hundred Dollars (\$100.00) for each employee employed by the Contractor or subcontractor, for each calendar day, or portion thereof, such employee is found to be employed in violation of 292.675 RSMo. Said amounts shall be withheld from all sums and amounts due under this provision when making payments to the Contractor.

- 2.6. EMPLOYMENT OF UNAUTHORIZED ALIENS PROHIBITED – Contractor shall comply with Missouri State Statute Section 285.530 in that they shall not knowingly employ, hire for employment, or continue to employ an unauthorized alien to perform work within the State of Missouri. As a condition for the award of this contract, the Contractor shall, by sworn affidavit and provision of documentation, affirm its enrollment and participation in a federal work authorization program with respect to the employees working in connection with the contracted services. The Contractor shall also sign an affidavit affirming that it does not knowingly employ any person who is an unauthorized alien in connection with the contracted services. Please return a copy of the Memorandum of Understanding that you will receive following completion of enrollment. This will provide the County the proof of enrollment.
- 2.6.1. Contractor shall require each subcontractor to affirmatively state in its contract with Contractor that the subcontractor shall not knowingly employ, hire for employment, or continue to employ an unauthorized alien to perform work within the State of Missouri. Contractor shall also require each subcontractor to provide Contractor with a sworn affidavit under the penalty of perjury attesting to the fact that the subcontractor’s employees are lawfully present in the United States.
- 2.7. PREVAILING WAGE - With submission of a bid response, Vendor acknowledges that any *major repair* service in this contract is subject to Missouri Prevailing Wage law. Repairs done by overhaul or replacement of major constituent parts that have deteriorated are “major repairs”. Any questions regarding “major repairs” should be addressed to the Boone County Purchasing Department. If the size, type or extent of the existing facility is changed or increased, the work performed is subject to the Prevailing Wage Law. Small repairs or maintenance type work will not be subject to prevailing wage rates. Maintenance is recurrent, day-today, periodic or scheduled work unless it involves the overhaul or replacement of major constituent parts. If work involves the repair but not the major repair or replacement of existing facilities, and the size, type or extent of the existing facility is not changed, it is maintenance. A copy of **Annual Wage Order 22** is reproduced verbatim and included with these bid documents, and is applicable to this contract. At any given time, the current “applicable” Prevailing Wage Order is available for review and a copy may be obtained in the office of the Director of Purchasing, 613 E. Ash, Room 110, Columbia, MO 65201; or email mbobbitt@boonecountymo.org , or call the Purchasing offices at 573-886-4391.
- 2.7.1. Wage Rates - “Major repair” work shall be based upon payment by the Contractor of wage rates not less than the prevailing hourly wage rate for each craft or classification of worker engaged on the work as determined by the Labor & Industrial Relations Commission of Missouri on behalf of the Division of Labor Standards. The Contractor shall comply with all requirements of the prevailing wage law of Missouri, Revised Statutes of Missouri, Section 290.210 to 290.340, including the latest amendments thereto. The prevailing wage law does not prohibit payment of more than the prevailing rate of wages nor does it limit the hours of work, which may be performed by any worker in any particular period of time.
- 2.7.2. Records - The Contractor and each subcontractor shall keep an accurate record showing names, occupations, and crafts of all workers employed, together with the

number of hours worked by each worker and the actual wages paid to each worker. At all reasonable hours, such records shall be open to inspection by representatives of the Labor & Industrial Relations Commission and Boone County. The payroll records shall not be destroyed or removed from the State for at least one (1) year after completion of the work. Contractors and Subcontractors will submit certified copies of their payrolls to the County prior to completed project's acceptance.

2.7.3. Notices - Throughout the life of this contract, a copy of the wage determination and the rules promulgated by the Labor & Industrial Relations Commission of Missouri shall be displayed in at least four (4) conspicuous places on the project under a heading of NOTICE with the heading in letters at least one inch (1") high.

2.7.4. Penalty - Pursuant to Section 290.250 RSMo, the Contractor shall forfeit to the County as a penalty, \$100.00 for each worker employed, for each calendar day, or portion thereof, such worker is paid less than the stipulated rates for any work done under the contract, by them or by a subcontractor under them.

2.7.5. Affidavit of Compliance - After completion of the work and before final payment can be made under this contract, the Contractor and each subcontractor must file with the County an affidavit stating that they have fully complied with the provisions and requirements of the prevailing wage law of Missouri, Section 290.210 to 290.340 RSMo.

2.7.6. Wage Determination - The prevailing hourly rate of wages is subject to change by the Labor & Industrial Relations Commission or by court decision, as provided by law. Any such change shall not be the basis of any claim by the Contractor against the County, nor will deductions be made by the County against sums due the Contractor by reason of such changes. The current Prevailing Wage Order provided at the beginning of each renewal term shall be used during the life of that contract term.

2.8. LIEN WAIVERS - Prior to the release of a project's final payment amount, Contractor shall file with the County a completed affidavit, to the effect that all payments have been made and all claims have been released for all materials, labor and other items covered by the contract.

2.9. SALES/USE TAX EXEMPTION – County will provide the Contractor with a Missouri Tax Exemption letter and, if applicable, a Missouri Project Exemption Certificate for Boone County, Missouri. The Contractor shall be responsible for furnishing the exemption certificate and tax exemption letter to all authorized subcontractors and suppliers providing materials incorporated in the work. All invoices issued for purchases for such materials, supplies and taxable rentals shall be in the name of Boone County and contain the project number assigned by Boone County for the contract awarded. It shall be the responsibility of the Contractor to ensure that no sales or use taxes are included in the invoices and that the County pays no sales/use taxes from which it is exempt. The Contractor shall be responsible for obtaining revised exemption certificates and revised expiration dates if the work extends beyond the estimated project completion date or a certificate expiration date. The Contractor shall also be responsible for retaining a copy of the project exemption certificate for a period of five (5) years and for compliance with all other terms and conditions of section 144.062 RSMo. not otherwise herein specified.

The Contractor agrees not to use or permit others to use the project exemption certificate for taxable purchases of materials or rentals and supplies not directly incorporated into or used in the work to which it applies and agrees to indemnify and hold the County harmless from all losses, expenses and costs including litigation expenses and attorney fees resulting from the unauthorized use of such project exemption certificates.

- 2.10. PROJECT MANAGER –Chad Martin, Director of Boone County Joint Communications Operations, 17 North 7th Street, Columbia, MO 65201.
- 2.11. INVOICES AND PAYMENT – Vendor shall send just **one** invoice to the County at completion of delivery and acceptance of goods/installation. All charges must be priced as listed on the vendor’s bid response. No additional fees or taxes shall be charged. The County’s Purchase Order Number must appear on the invoice. The County agrees to pay the invoice within thirty (30) days from receipt of a correct invoice and all other required documents. A lump sum payment shall be made upon acceptance by Boone County. Invoices shall be submitted to Boone County Joint Communications Operations, 17 N. 7th Street, Suite A, Columbia, MO 65201.
- 2.12. BONDS – Bidders submitting a bid amount exceeding \$50,000.00 are required to furnish the following bonds.
- 2.12.1. Bid Bond – Bidder shall include with bid a certified check, Treasurer’s check or cashier’s check, or a bidder’s bond payable to the County of Boone for five percent (5%) of Amount Of Bid. If this bid is accepted and the undersigned fails to execute the Contract and furnish a contract bond as required, then the bid guaranty shall be forfeited to the County. Bid guaranties will be returned as per Section 103.3, Missouri Standard Specifications for Highway Construction.
- 2.12.2. Performance Bond & Labor and Materials Payment Bond – The successful Contractor shall pay for and furnish, when applicable, within ten (10) days after written notice of acceptance of estimate, a Performance Bond and a Labor and Materials Payment Bond. Contractor shall provide and pay the cost of both bonds, each in the full amount of the “Not to Exceed” amount for the estimated work. Bonds shall be issued by a Surety Company licensed in Missouri, with an “A” minimum rating of performance as stated in the most current publication of Best’s Key Rating Guide, Property Liability, which shall show a financial strength rating of at least five (5) times the Contract Price. Each bond shall be accompanied by a Power of Attorney authorizing the Attorney-in-Fact to bind the Surety and certified to include the date of the bond.

3. PRIMARY SPECIFICATIONS

- 3.1. SCOPE OF WORK – The County of Boone seeks to purchase furniture as described in the attached Furniture Bid Specifications, Teknion Expansion Desking specifications and Director’s office specifications for the new Emergency Communications Center building located at 2145 East County Drive, Columbia, MO 65202.
- 3.2. Bidder shall propose a solution compatible with the Boone County specifications outlined in the attached Furniture Bid Specifications. Following review of the proposed solution, County may discuss additions, modifications and deletions to proposed furniture.
- 3.3. FURNITURE REQUIREMENTS:
 - 3.3.1. The furniture should be freestanding, easy access to building power, re-configurability, case good components from the same manufacturer, and LED lighting.
 - 3.3.2. The furniture shall be freestanding so the County can move office components without concern to wall placement.
 - 3.3.3. Boone County moves furniture to different locations from time to time and in different configurations from the original setup. It’s important that the furniture be able to be reused in other configurations and maintain structural stability. Metal screws into threaded metal inserts are needed as opposed to wood screw going directly into surfaces to ensure the ability of the piece to be reused.
 - 3.3.4. All shared and private offices should have easy access to building power. There will be many items that will need to plug into build power and data. Modesty panels should not block electrical or data outlets to allow easy access to power and data.
 - 3.3.5. The casegoods in the office shall be from the same manufacturer (i.e. desk from one manufacturer and pedestal drawers should be from the same manufacturer).
 - 3.3.6. Boone County has upgraded to LEDs (Light Emitting Diodes) throughout their buildings which have contributed to a significant amount of savings. All task lighting must be LED as opposed to a conventional bulb.
- 3.4. MATERIALS – All materials provided by the vendor shall be new material and meet the minimum requirements as stated in the Furniture Bid Specifications.
 - 3.4.1. Samples – Bidders are asked to submit a sample of the work surface, panel construction, and finish materials. There shall be no charge to the County for materials taken as samples.
- 3.5. INSTALLATION – The building where installation is to occur is vacant. In order to gain access to the building, work days shall be coordinated with the Project Manager a minimum of twenty-four (24) hours in advance. Installation shall occur between the hours of 8:00 a.m. and 5:00 p.m., Monday through Friday, unless special arrangements are made with the Project Manager.
 - 3.5.1. Workmanship – Workers shall make every effort to flawlessly install the furniture. New materials that have been dented, scratched, or damaged in any way by mishandling of the product before or during installation shall not be used. Where

not more specifically described in the Furniture Bid Specifications, workmanship shall conform to all of the methods and operations of best standards and accepted practices of the trade or trades involved, and shall include all items of fabrication, construction or installation regularly furnished or required for completion (including any finish, and for successful operations as intended). All work shall be executed by personnel skilled in their respective lines of work.

3.5.2. Damages – Damage done to the building’s interior or existing items and structures within the building during the course of the work performed shall be repaired and restored to a condition equal to or better than it was before commencement of work at the vendor’s expense.

3.6. DELIVERY AND HANDLING – Items purchased shall be delivered to the Boone County Emergency Communications Center, 2145 East County Drive, Columbia, MO 65202.

3.6.1. Inside delivery shall be made FOB Destination unloaded and installed. Freight charges are fully included and prepaid. The vendor pays and bears the freight charges.

3.6.2. All deliveries shall be made between the hours of 8:00 a.m. and 5:00 p.m. Central Time, Monday through Friday, excluding holidays. Deliveries shall be coordinated with the Project Manager in order to gain access to the vacant building.

3.7. CLEANUP – The Contractor shall keep the premises clean of all rubbish and debris generated by the work involved. The work area shall be cleaned at the end of each workday. All materials, tools, equipment, etc., shall be removed and stored out of the way of other work crews that may also be working within in the building.

3.8. WARRANTY AND GUARANTEE – Vendor warrants and guarantees to the Owner that all work will be in accordance with the contract documents and will not be defective. All materials provided by vender shall be new material of high quality which shall give long life and reliable operation. All defective work, whether or not in place, may be rejected, corrected, or accepted as follows.

3.8.1. Correction or Removal of Defective Work – If required by the Project Manager, vendor shall promptly, as directed, either correct all defective work, whether or not fabricated, installed, or completed, or if the work has been rejected by the Project Manager, remove it from the site and replace it with non-defective work. Vendor shall bear all direct, indirect, and consequential costs of such correction or removal.

3.8.2. One (1) Year Correction Period – If within one (1) year after the date of substantial completion or such longer period of time as may be prescribed by laws or regulations or by the terms of any applicable special guarantee required by the contract documents or by any specific provision of the contract documents, any work or product is found to be defective, vendor shall promptly, within ten (10) days, without cost to the Owner and in accordance with Owner’s written instructions, either correct such defective work, or if it has been rejected by Owner, remove it from the site and replace it with non-defective product or work. If the vendor does not promptly comply with the terms of such instructions, or in an emergency where delay would cause serious risk of loss or damage, Owner may have the defective work removed and replaced and all direct, indirect, and

consequential costs of removal and replacement shall be paid by the vendor. In special circumstances where a particular item is placed in continuous service before substantial completion of the work, the correction period for that item may start to run from an earlier date if so provided in the specifications or by written amendment.

3.8.3. Warranty from the Manufacturer – At the completion of the project, vendor shall furnish owner with warranty information from the manufacturer. A sample of the warranty should be submitted with the bid response.

3.9. INSPECTIONS – The Project Manager has direct charge of the project details. The Project Manager has the authority to reject defective material and to suspend and reject any work that is being improperly performed. The owner shall at all times have access to the work whenever it is in preparation or progress.

3.9.1. Unless otherwise specified, all materials shall be subject to visual inspection and job control test, as determined by the Project Manager.

3.9.2. The awarded vendor shall request the Project Manager to conduct a site inspection after the project is complete. Final project approval is contingent upon the Project Manager's final inspection and written approval.

3.10. GENERAL

3.10.1. Bidders shall be responsible for obtaining room measurements. Bidders have the sole responsibility for accuracy of all measurements and for estimate of material quantities required to satisfy requirements of contract documents.

3.10.2. If a contradiction in the contract documents occurs, the more restrictive interpretation shall prevail.

3.10.3. All work on the site is to be performed safely in accordance with all Occupational Safety and Health Administration (OSHA) standards and safety programs. It is the responsibility of the Contractor to inform and educate all personnel working on the site of the safety requirements and ensure that these policies are enforced each day.

3.10.4. The County of Boone is an equal opportunity affirmative action employer, pursuant to federal and state laws, and all bidders submitting bids shall be considered to be EEO/AA employers in compliance with federal and state laws unless otherwise stipulated by the bidders herein.

3.10.5. The awarded vendor shall be represented at the site by a competent full-time supervisor from the beginning of the work until acceptance.

3.10.6. If requested by the County personnel, the vendor shall be required to attend job progress meetings.

3.10.7. No subcontractors shall be used without prior approval from the Project Manager.

3.10.8. **Or Equal:** Bidders are to bid as specified herein or bid an approved equal. Determination of equality is solely Boone County's responsibility.

3.10.9. **Descriptive Literature:** Bidders proposing to furnish items other than specified must submit Complete Descriptive Literature with bid. Bids received without descriptive literature are subject to rejection.

3.10.10. **Deviations:** It is the bidder's responsibility to submit a bid that meets all mandatory specifications stated within. The bidder must compare their product bid

with the required listed minimum specifications and identify any deviations along with the specific section deviated from. Failure to properly identify deviations may render the bidder's proposal non-responsive and not capable of consideration for award. Bidders should note that a descriptive brochure of the model bid may not be sufficient or acceptable as proper identification of deviations from the written specifications.

3.10.11. **Additional Items:** Additional items may be identified after the contract is established that would fall under the scope of work. The County reserves the right to add products to the contractual agreement with the approval of the successful vendor.

3.10.12. **NOTE:** CAD drawings will be provided to the Contractor at time of award.

4. RESPONSE PRESENTATION AND REVIEW

- 4.1. RESPONSE CONTENT - In order to enable direct comparison of competing Responses, Bidder is to submit their Response in strict conformity to the requirements stated here. Failure to adhere to all requirements may result in your Response being disqualified as non-responsive. All Responses must be submitted using the provided Response Sheet. Every question must be answered and if not applicable, the section must contain "N/A" or "No Bid". Manufacturer's published specifications for the items requested shall be included with the response.
- 4.2. SUBMITTAL OF RESPONSES - Responses are to be received by the date and time noted on the title page under "Bid Submission Information and Deadline". NO EXCEPTIONS. We are not responsible for late or incorrect deliveries from the U.S. Postal Service or any other mail carrier.
 - 4.2.1. Submittal Package - Submit, to the location specified on the title page, **three (3) complete copies** of your Response in a single sealed envelope, clearly marked on the outside with your company name and return address, **the bid number** and the due date and time.
- 4.3. ADVICE OF AWARD - A Bid Tabulation of responses received as well as Award status can be viewed at www.showmeboone.com.
- 4.4. BID OPENING - On the date and time and at the location specified on the title page under "Bid Opening", all Responses will be opened in public. Brief summary information from each will be read aloud.
- 4.5. REMOVAL FROM VENDOR DATABASE - If any prospective Bidder currently in our Vendor Database to whom the Bid was sent elects not to submit a Response and fails to reply in writing stating reasons for not bidding, that Bidder's name may be removed from our database. Other reasons for removal include unwillingness or inability to show financial responsibility, reported poor performance, unsatisfactory service, or repeated inability to meet delivery requirements.
- 4.6. RESPONSE CLARIFICATION - We reserve the right to request additional written or oral information from Bidders in order to obtain clarification of their Responses.
- 4.7. REJECTION OR CORRECTION OF RESPONSES - We reserve the right to reject any or all Responses. Minor irregularities or informalities in any Response which are immaterial or inconsequential in nature, and are neither affected by law nor at substantial variance with Bid conditions, may be waived at our discretion whenever it is determined to be in the County's best interest.
- 4.8. EVALUATION PROCESS - Our sole purpose in the evaluation process is to determine from among the Responses received which one is best suited to meet the County's needs at the lowest possible cost. Any final analysis or weighted point score does not imply that one Bidder is superior to another, but simply that in our judgment the Contractor selected

appears to offer the best overall solution for our current and anticipated needs at the lowest possible cost. Bid evaluation will be based on quality, reliability, delivery time after receipt of order, and cost. Quality and reliability may be determined by using information contained in product reviews from established publications and demonstration of machine. Availability of parts, speed of service, and location of service/warranty work will weigh into consideration of award.

4.9. METHOD OF EVALUATION - We will evaluate submitted responses in relation to all aspects of this Bid.

4.10. ACCEPTABILITY - We reserve the sole right to determine whether goods and/or services offered are acceptable for County use.

4.11. ENDURANCE OF PRICING - Your pricing must be held until contract execution or sixty (60) days, whichever comes first. In the cost evaluation, a unit price conversion will be done to fairly evaluate bid prices. However, for any resulting contract, the unit of measure bid will be the unit of measure awarded. The bidder is cautioned that the County reserves the right to clarify the unit of measure modification or to disqualify the bid for that line item if the unit of measure modification is not deemed appropriate or in the best interests of the County.

5. RESPONSE FORM

Company Information:

Name: _____

Address: _____

Phone Number: _____ Fax Number: _____

Email: _____ Federal Tax ID: _____

- Corporation
- Partnership Name: _____
- Individual/Proprietorship Name: _____
- Other: _____

The undersigned offers to furnish, deliver and install the articles or services as specified at the prices and terms stated and in strict accordance with the specifications, instructions and general conditions of bidding which have been read and understood, and all of which are made part of this order.

Authorized Representative (Print Name): _____

Signature

Date

Materials, Installation, and Labor Costs: All materials provided by Contractor shall be new materials of high quality that shall give long life and reliable operation.

Complete the following page: Manufacturer, Series, Unit Price and Extended Price.

Summary Code	Product	Manufacturer	Series	Unit Price	Qty	Extended Price
D1	Directors Casegoods				2	
D2-a	Private Office Casegoods				9	
D2-b	Private Office Casegoods				3	
D3-a	Shared Office				1	
D3-b	Shared Office				1	
D3-c	Shared Office				1	
D4	Conference Room				3	
C1	Guest Chair				43	
C2	XL Guest Chair				1	
C3	Side Chair				1	
C4	Nesting Chair				78	
C5	Task Chair				28	
C6	Wood Chair				12	
C7	Stack Chair				12	
C8	Conference Chair				35	
T1-a	Round table				3	
T1-b	Training table with Fixed Leg				7	
T2	Computer Training				8	
T3	Training table with Flip top				4	
T4	Height Adjustable table				1	
T5	Conference Table				3	
T6	Wood meeting table				2	
T7	Night Stand				4	
T8	End Table				2	
T9	Magazine Table				1	
T10	Instructor's Desk				1	
E1	Dual Monitor Arms				26	
E2	Keyboard Tray				26	
E3	CPU Holder				42	
E4	Surface Mounted Power				26	
E5	LED Task Light				26	
F1	Lateral file 4H 36" wide				4	
F2	Lateral File 4H 30" wide				4	
O1	Bunk Beds				12	
O2	Mattresses				12	
O3	Night Stand Shelf				6	
	Subtotal					
	Installation					
	Grand Total					

Percent discount from list should other item(s) be identified after contract award that need to be added to scope of work: _____%.

Work will begin on project _____ days after the receipt of the Notice to Proceed.
 Work will be completed _____ days after receipt of the Notice to Proceed.

List any deviations from bid specifications:

ATTACHMENTS:

Teknion Expansion Desking
Director's Office Specifications (based off OFS Denali)
Boone County 911 Center - Furniture Bid Specifications
Statement of Bidder's Qualifications and Prior Experience
Compliance with House Bill 1549, Work Authorization Certification, & Certification
of Individual Bidder and Affidavit
Certification Regarding Debarment
Affidavit for Compliance with Prevailing Wage
Affidavit of Compliance with OSHA Training
Standard Terms and Conditions
No Bid Response Form
State Prevailing Wage Order No. 22

Teknion Expansion Desking Specifications

1. Surfaces shall be constructed of high pressure laminate (HPL) hot glued to a 1-1/8" thick, 45 lbs./ft. density, particle board and corresponding backer for a total thickness of 1-3/16".
2. Surface edge banding shall be of 3mm abs straight trim and color coordinate to the laminate color.
4. Work surface dimensions should be actual dimensions.
5. Cross-grain direction work surface shall be available to allow uniform grain direction on an overall workstation
6. Assembly shall be of a metal to metal connection and all connections shall be machine screws and threaded metal inserts.
7. Desks should have a functional load of 360 lbs.
8. Desk height should be 29" high from the finished floor to the top of the finished work surface with a leveling range of 29" to 32".
9. All desks shall use structural columns to vertically mount all components above the work surface at any height including: overhead cabinets, framed elements (tack boards) and accessory rails.
10. Modesty panels should not be required for structural stability.
11. When no modesty panel is specified in the drawing, it shall permit a 24" of vertical clearance, wall access.
12. All private offices shall have a suspended modesty panel on the desk portion facing guests

Under work surface Storage

1. The case shall be metal with laminate drawer fronts. Drawer front edge trims shall coordinate with the laminate fronts.
2. All drawers shall provide full extension slides with the following loading capacity in order to comply with BIFMA standards.

Structural Columns

1. The desk shall use columns to mount the overheads; The column should offer a wire management solution for utility lights.

Framed Elements (tack boards)

1. Framed elements shall be mounted to two structural columns and shall be installed on work surfaces.
2. Framed elements should be 1" thick and shall be available in four heights: 13", 15", 22", and 37" and shall offer a wide variety of widths that suit desk dimensions.
3. Framed elements will match the overall width dimension of the work surface where they are mounted.

Mounted Storage

1. Overheads shall be mounted on structural columns,
2. Cases shall be metal with hinged laminate doors

Accessory Rail

1. The accessory rail shall be mounted on structural columns at to support personal organizers such as paper trays.
2. The accessory rail shall not interfere with column mounted elements.
3. Three levels in the groove of rail shall accommodate the hinging of letter sized divisional sorters and paper trays at three different heights.

Director's Office Specifications (based off OFS Denali)

VENEER

Exposed surfaces should be cherry or maple veneers. Drawer fronts should be matched to assure proper grain balance.

WORK SURFACES

Work surfaces should be 1.875" thick utilizing 5-ply construction and are profiled on all sides. The edge style should be a Corona Style.

FILE DRAWERS

All file drawers should accommodate letter or legal filing. Filing hardware should be black powder coated to prevent corrosion.

DRAWER CONSTRUCTION

Drawer sides should be made with 0.4375" thick unidirectional plywood drawer sides and backs and assembled using rigid dowel construction. Drawers should have 0.25" thick drawer bottoms. Drawer interiors shall be sanded and finished.

DRAWER SUSPENSION

Drawer suspensions should have a lifetime warranty. Box and file drawers shall have full extensions. The suspension systems should feature positive and cushioned in/out stops and steel ball bearings to ensure a smooth ride.

LOCKING

Each pedestal shall lock with the turn of a single key. All units are standard shipped keyed alike. Removable lock cores are required for re-keying in the field.

ASSEMBLY

Structural joints should be secured by 16-gauge steel angle brackets and wood glue blocks. Adjustable levelers feature insert nuts to prevent glide tear out.

FINISH

All Bidders shall provide casegoods with a finish similar to Euroluxe™. The Euroluxe finish is a chemically re-engineered Urethane clear coat that preserves the beautiful depth and clarity of OFS' finishes, but allows for much greater performance with chemical and scratch resistance, as well as the complete elimination of dangerous formaldehyde emissions. The Euroluxe™ finish system achieves indoor air quality standards set by LEED and BIFMA furniture emission

standards and allows all products to achieve SCS Global Services' Indoor Advantage Gold Certification.

SilverBan™ technology is an antimicrobial utilizing silver ions infused into the Euroluxe™ wood finish for antimicrobial protection on all exposed wood surfaces. SilverBan™ inhibits the growth of mold, mildew, fungus and bacteria on wood surfaces, as well as odors caused by bacterial growth, by 99.99%.

Boone County 911 Center

Furniture Bid Specs

Boone County 911 Center Typicals – Directors Office

Manufacturer: OFS
Finishes: Wood - Honey Maple
Edge Profile - Corona
Tackboard Fabric - Momentum Vox Mystic

Accessories Package: ECA Power, Keyboard Tray,
CPU Holder, Dual Monitor Arm, LED Task Light

Code: D1

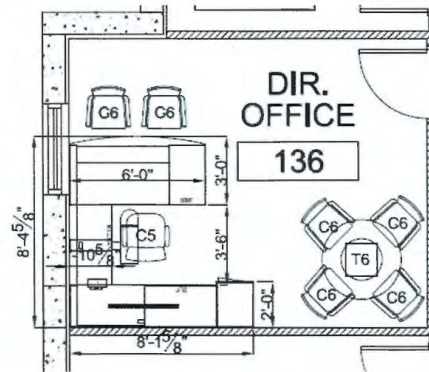
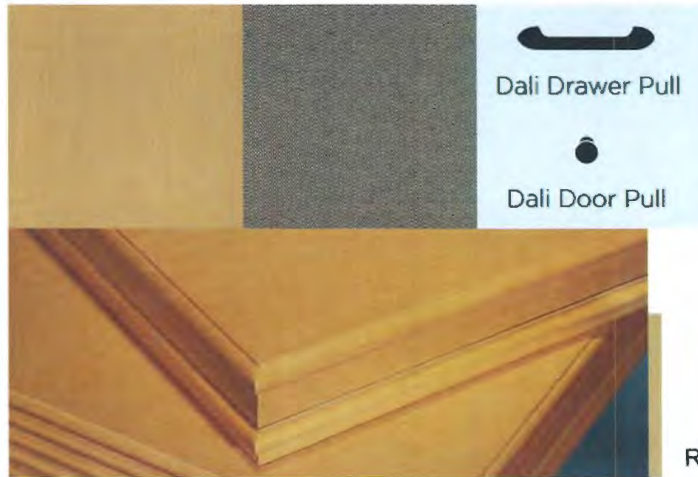
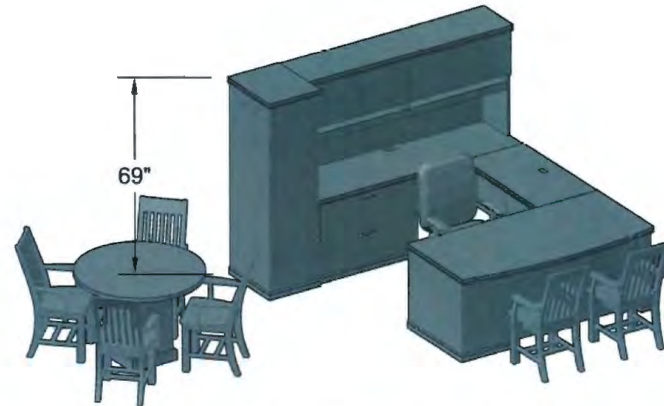

Rms 109 & 136

Boone County 911 Center Typicals – Private Office

Manufacturer: Teknion
 Finishes: Laminate - Stainless
 Metal - Granite
 Edge - Stainless
 Pull Style/Finish - Rectilinear/Granite
 Tackboard Fabric - Teknion Wales Newport

Accessories Package: ECA Power, Keyboard Tray,
 CPU Holder, Dual Monitor Arm, LED Task Light,
 3 Paper Trays, 3 Division Sorters

Code: D2-a

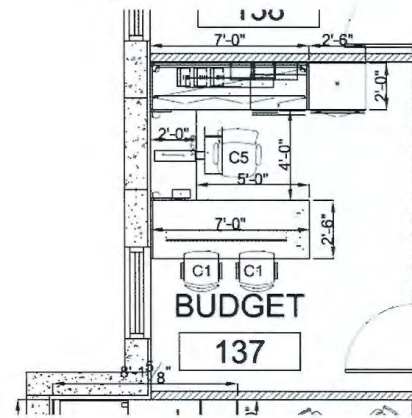
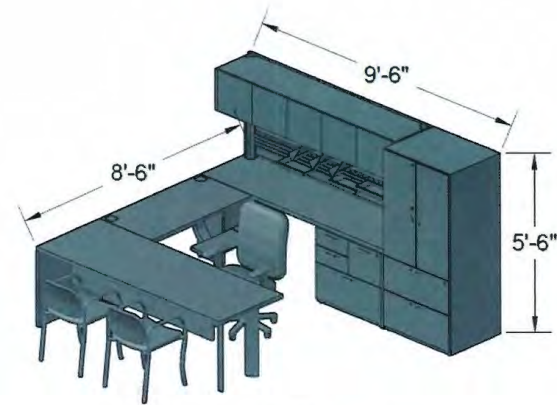
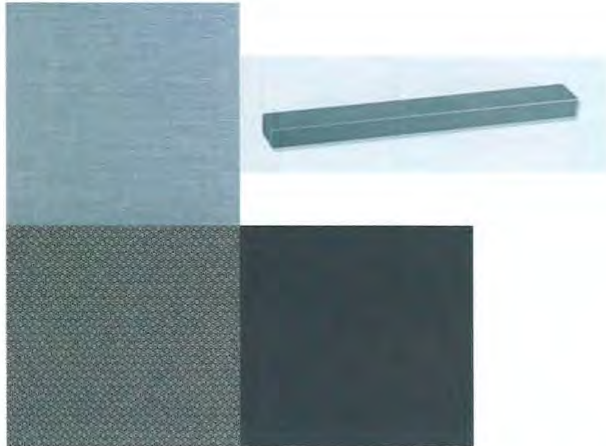

Rms 107,108,111,137,138,139,141,142,143

Boone County 911 Center Typicals – Private Office

Manufacturer: Teknion
 Finishes: Laminate - Stainless
 Metal - Granite
 Edge - Stainless
 Pull Style/Finish - Rectilinear/Granite
 Tackboard Fabric - Teknion Wales Newport

Accessories Package: ECA Power, Keyboard Tray,
 CPU Holder, Dual Monitor Arm, LED Task Light,
 3 Paper Trays, 3 Division Sorters

Code: D2-b

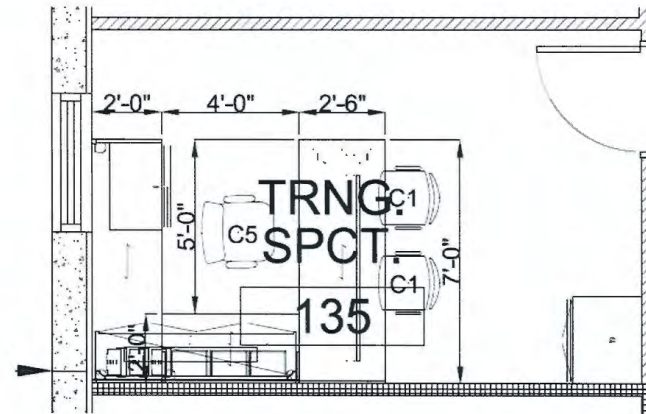
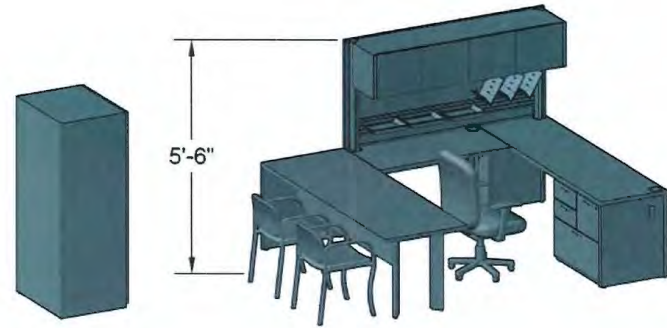
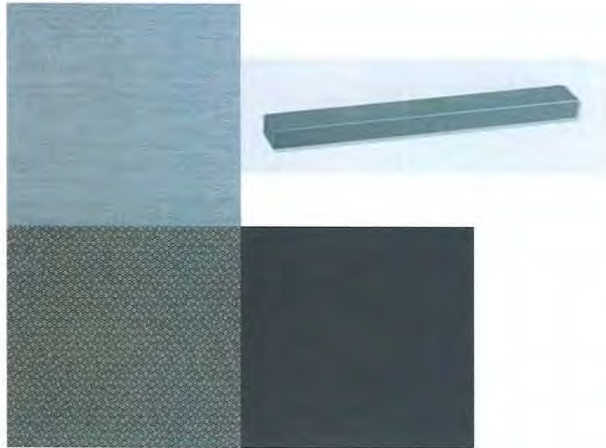

Rms 110,112,135

Boone County 911 Center Typicals – Shared Office

Manufacturer: Teknion
 Finishes: Laminate - Stainless
 Metal - Granite
 Edge - Stainless
 Pull Style/Finish - Rectilinear/Granite
 Tackboard Fabric - Teknion Wales Newport

Accessories Package: ECA Power, Keyboard Tray,
 CPU Holder, Dual Monitor Arm, LED Task Light,
 3 Paper Trays, 3 Division Sorters

Code: D3-a

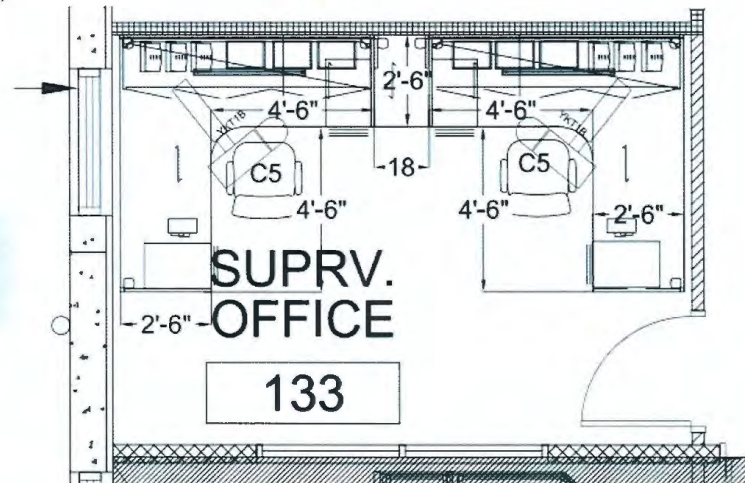
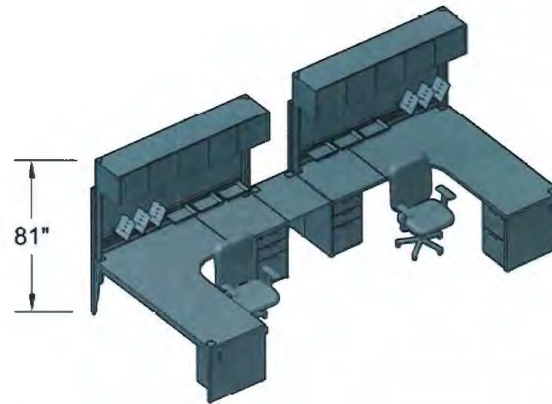
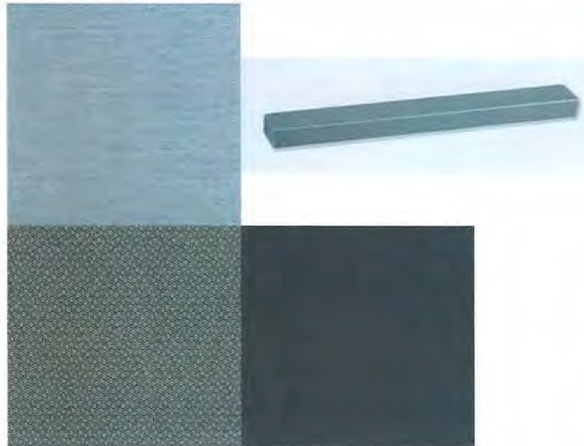

Rm 133

Boone County 911 Center Typicals – Shared Office

Manufacturer: Teknion
 Finishes: Laminate - Stainless
 Metal - Granite
 Edge - Stainless
 Pull Style/Finish - Rectilinear/Granite
 Tackboard Fabric - Teknion Wales Newport

Accessories Package: ECA Power, Keyboard Tray,
 CPU Holder, Dual Monitor Arm, LED Task Light,
 3 Paper Trays, 3 Division Sorters

Code: D3-b

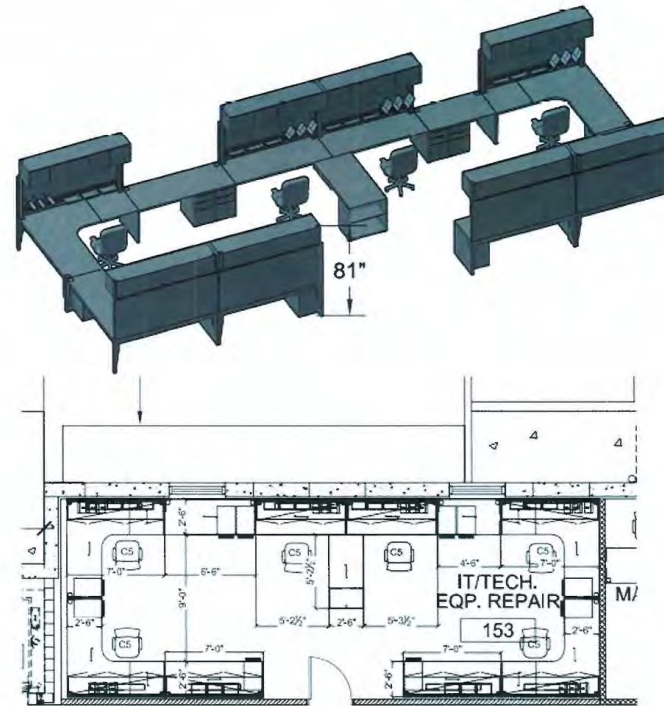
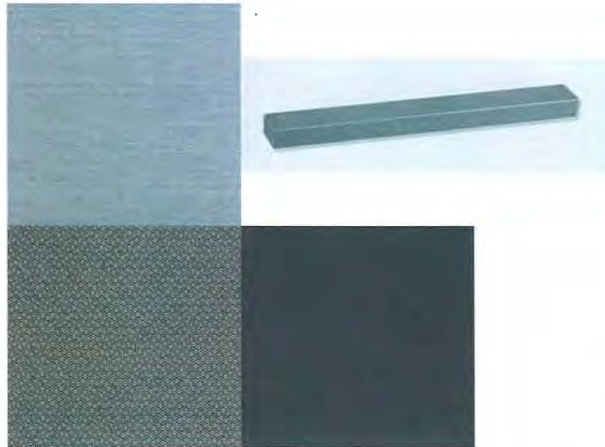

Rm 153

Boone County 911 Center Typicals – Shared Office

- Manufacturer: Teknion
- Finishes: Laminate - Stainless
- Metal - Granite
- Edge - Stainless
- Pull Style/Finish - Rectilinear/Granite
- Tackboard Fabric - Teknion Wales Newport

Accessories Package: ECA Power, Keyboard Tray, CPU Holder, Dual Monitor Arm, LED Task Light, 3 Paper Trays, 3 Division Sorters

Code: D3-c

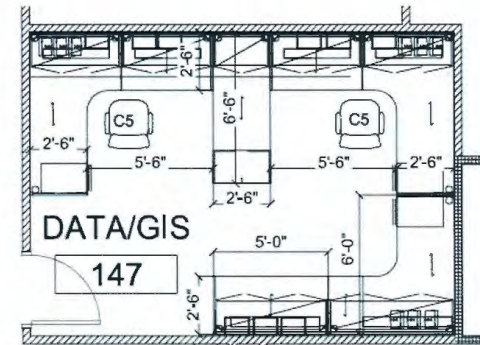
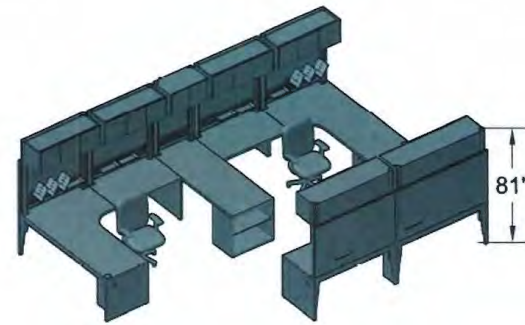
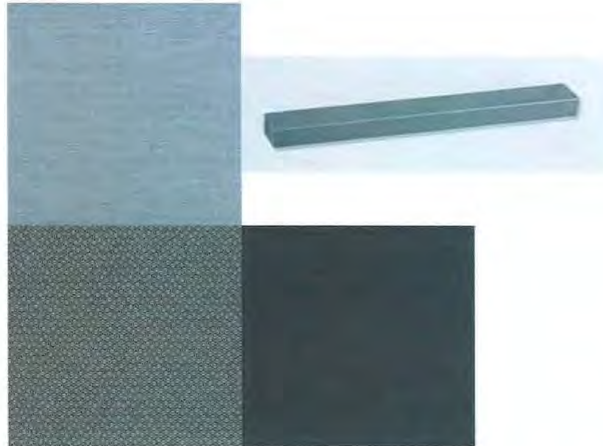

Rm 147

Boone County 911 Center Typicals – Conference Room

Manufacturer: Teknion
Finishes: Laminate - Stainless
 Metal - Granite
 Edge - Stainless

Code: D4

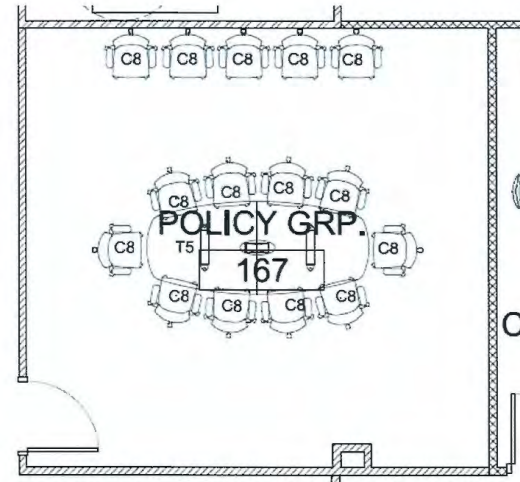
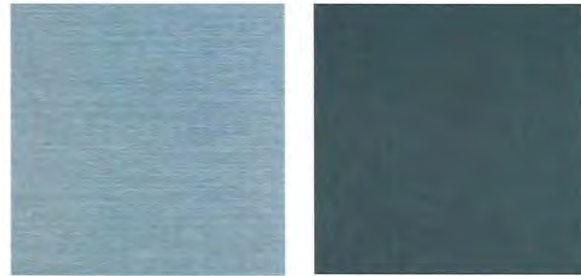

Rms 117,166,167

Boone County 911 Center Large Classroom 170 Code: D5

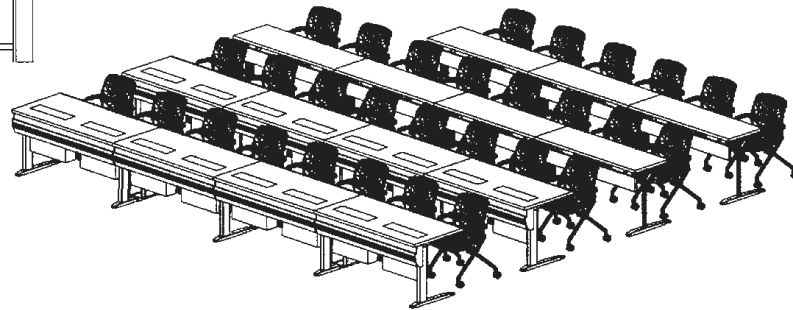
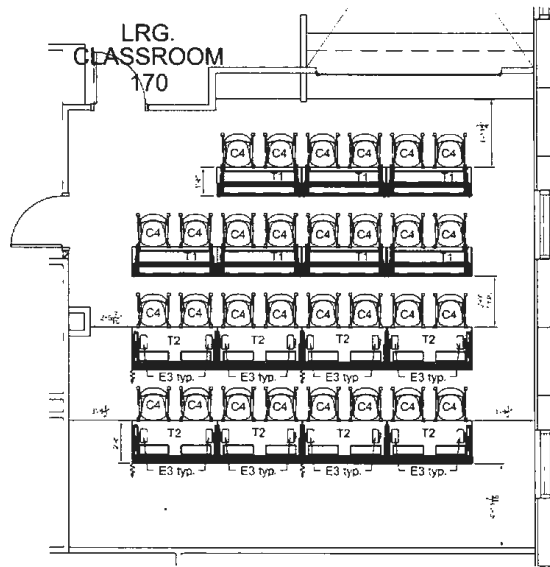

Boone County 911 Center Seating

Manufacturer: KI

Style: Versa Basic Chair

Model #: VBWAL/WG/NFRGRPP1REVERB/27.196.084.P27.144.092

MK:16111451

Code:C1

Color/Finish: Warm Grey

Fabric: Back - Pallas Textiles Reverb Foggy Notion

Seat - Pallas Textiles Holy Cow Thunderstorm

Quantity: 43



Boone County 911 Center Seating

Manufacturer: KI

Style: Versa XL Chair

Model #: VXLAN/WG/NFRGRPP1REVERB/27.196.084.P/P/VRB27.144.092

MK: 16111453

Code: C2

Color/Finish: Warm Grey

Fabric: Back - Pallas Textiles Reverb Foggy Notion

Seat - Pallas Textiles Holy Cow Thunderstorm

Quantity: 1

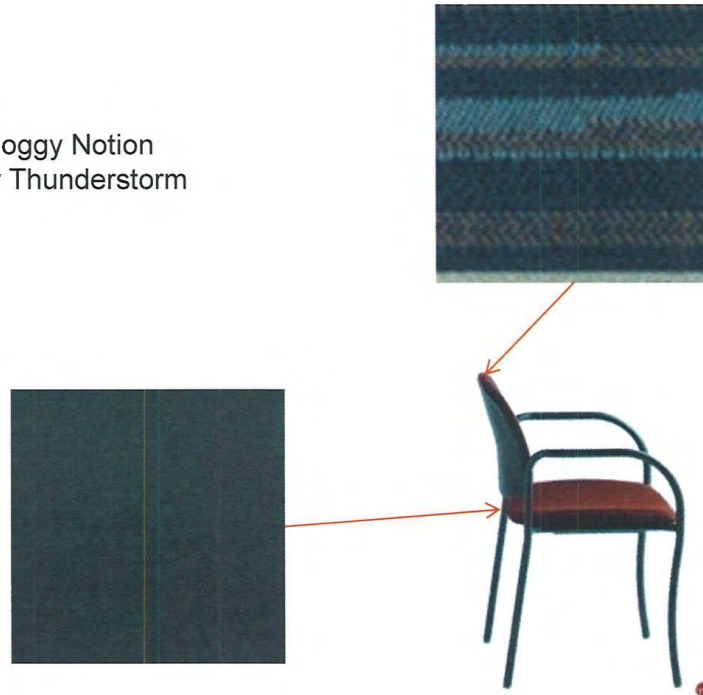

Boone County 911 Center Seating

Manufacturer: Carolina
Style: Orchestra Mini Recliner
Model #: 1478-R
Code: C3

Color/Finish: Honey Maple
Fabric: ArcCom Fabric Moon Beam Midnight #8

Quantity: 1

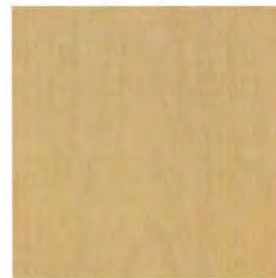

Boone County 911 Center Seating

Manufacturer: KI

Style: Torsion on the Go!

Model #: TGWAUB/CH/NFRGRPP/GRILLCLOTH/27.197.112P/C-NFR/PWG

Code: C4

Color/Finish: Warm Grey

Fabric: Pallas Textiles Grill Cloth Battleship

Quantity: 78

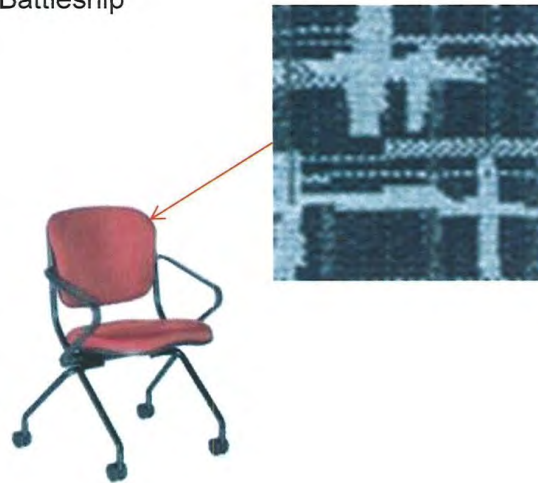

Boone County 911 Center Seating

Manufacturer: KI

Style: Impress Task Chair

Model #: KI62/JR39/NF/POLY/NFR SOFT KNIT/SMOKE/C-NS/SLD

Code: C5

Color/Finish: N/A

Fabric: KI Soft Knit Smoke

Quantity: 28



Boone County 911 Center Seating

Manufacturer: KI
Style: CrossRoads Wood Armchair
Model #: CRCHRA18/M/MMT
Code: C6

Color/Finish: Monticello Maple
Fabric: N/A

Quantity: 12



Boone County 911 Center Seating

Manufacturer: KI
Style: Maestro Chair
Model #: MSP/WG/NFR/PWG/NS
Code: C7

Color/Finish: Frame - Warm Grey
Seat/Back - Warm Grey

Quantity: 12



Boone County 911 Center Seating

Manufacturer: KI
Style: Altus Mesh Conference Chair
Model #: ALTCLA/P/AR/C/NFRA1A1UPHALTUS/A1MN/AMBL
Code: C8

Color/Finish: N/A
Fabric: Back - KI Mesh Black
Seat - KI Black Upholstery

Quantity: 35

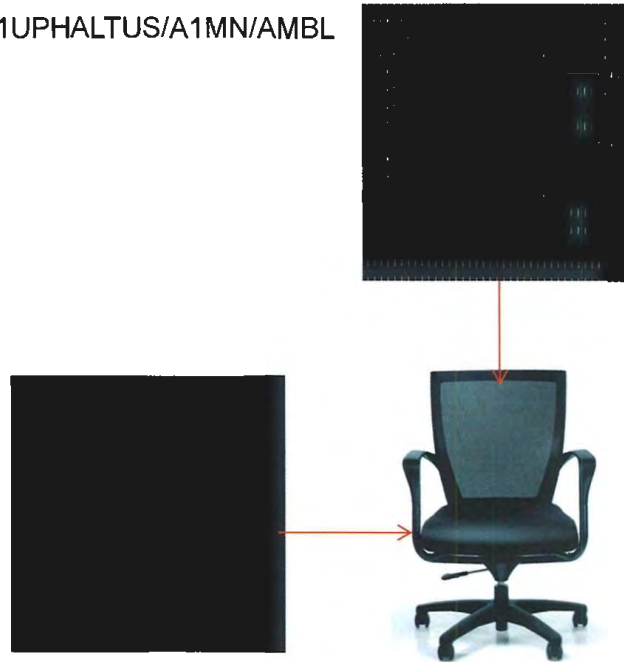

Boone County 911 Center Tables

Manufacturer: KI
Style: Round Portico Table
Model #: PR35FX-74P/EWG Standard/LCA/CH-NCST/PWG-NO-NWMODINFO2
Code: T1-a

Finishes: Laminate - Canyon Zephyr
Metal - Starlight Silver

Quantity: 3

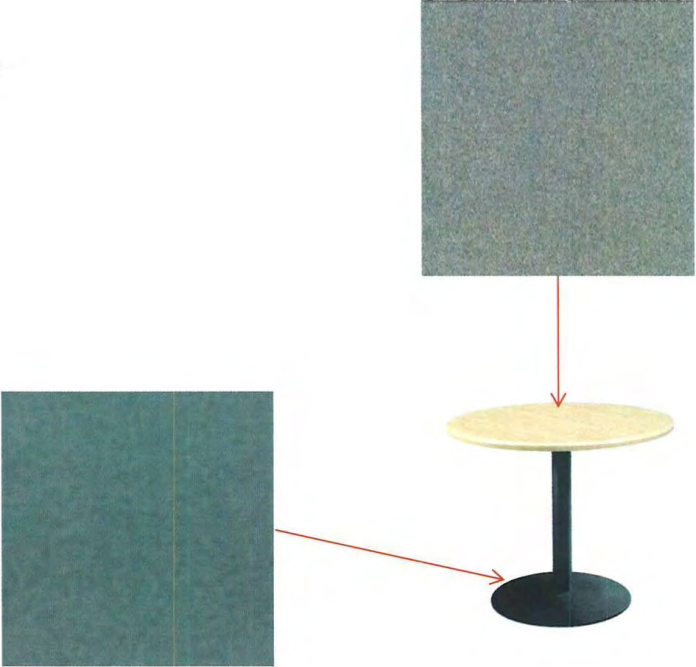

Boone County 911 Center Tables

Manufacturer: KI

Style: Portico Table

Model #: P155F/M-74P/EWG Standard/LCA/WG-NCST/PWG-NO-NWMODINFO2

Code: T1-b

Finishes: Laminate - Canyon Zephyr
Metal - Starlight Silver

Quantity: 7

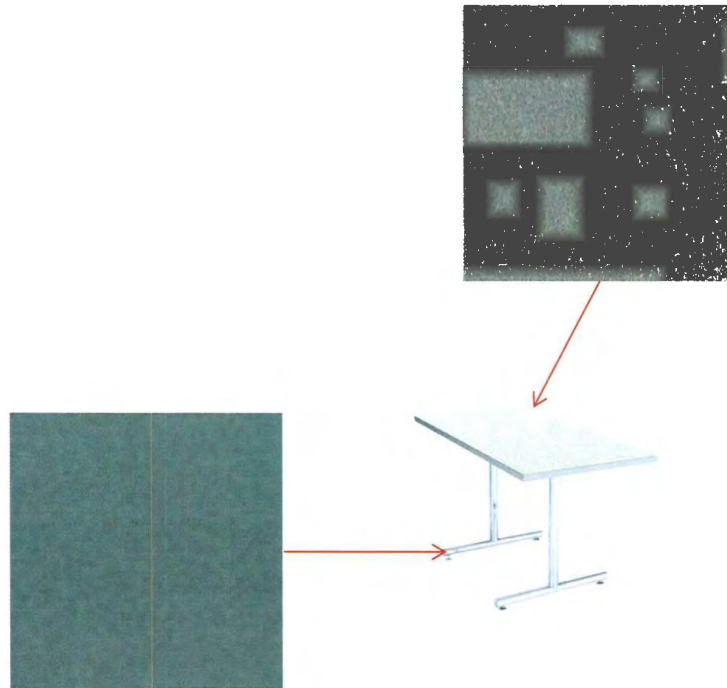

Boone County 911 Center Tables

Manufacturer: KI

Style: Smart Lift Table

Model #: ISMT3060-74P/N/S/ELK STANDARD/LCA/WG/EWG

Leg: ITFL3029/WG

Power: AC8IF.108, AC8JP.29, AC8RPTIT.12, S16111513, S16111514, S16111515

Code: T2

Finishes: Laminate - Canyon Zephyr

Metal - Starlight Silver

Edge - Warm Grey

Quantity: 8

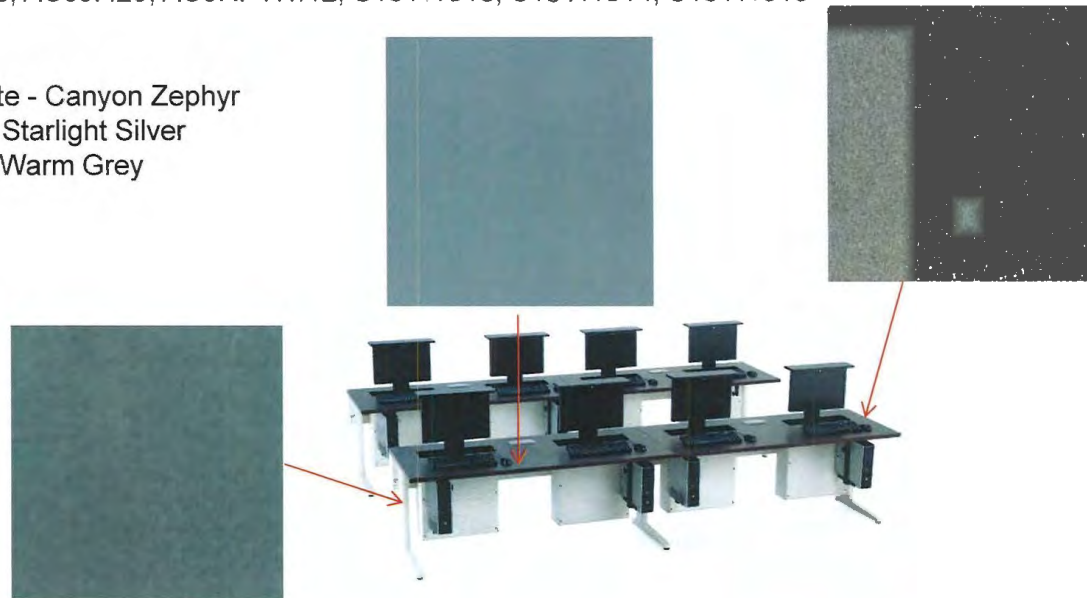

Boone County 911 Center Tables

Manufacturer: KI
Style: Hurry Up! Table
Model #: HUN2060-74P
Code: T3

Finishes: Laminate - Canyon Zephyr
Metal - Starlight Silver
Edge - Warm Grey

Quantity: 4

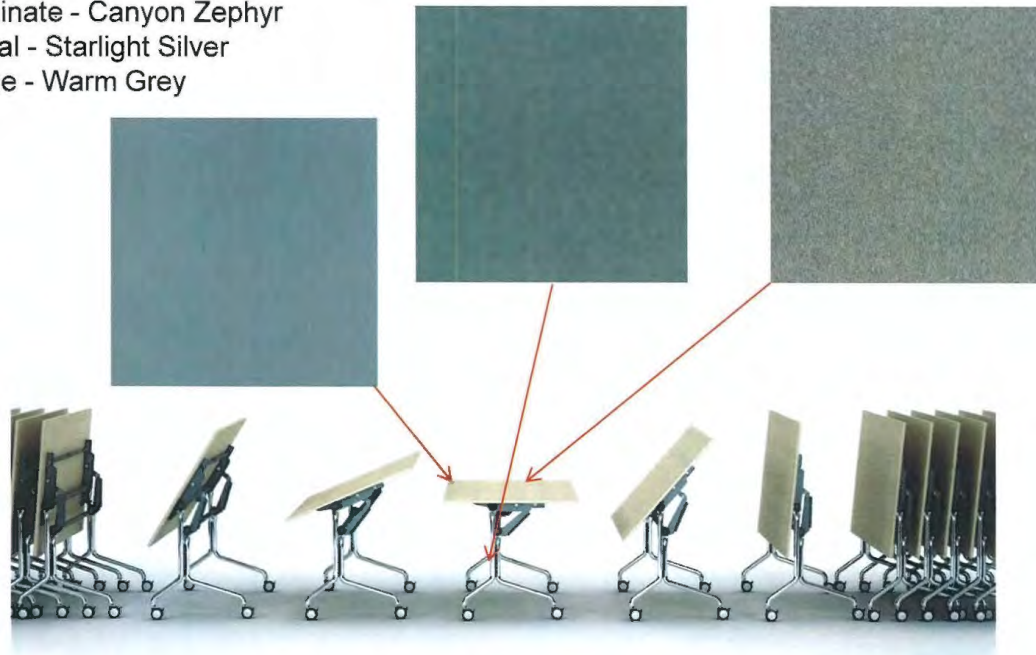

Boone County 911 Center Tables

Manufacturer: Teknion
Style: Livello Height Adjustable Table
Model #: LVWR7SL3072 A JG 6 SV FOUNDAT J NN S N
Code: T4

Finishes: Laminate - Stainless
Metal – Granite

Quantity: 1

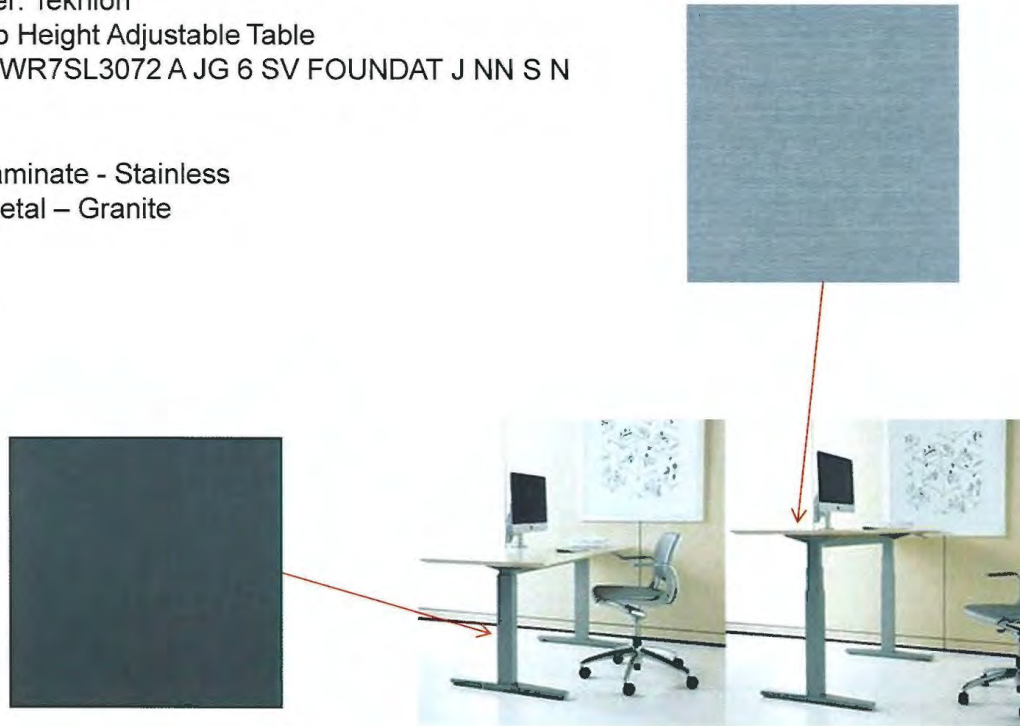

Boone County 911 Center Tables

Manufacturer: Teknion
Style: Expansion Conference Table
Model #: BCMCRR481141
Code: T5

Finishes: Laminate - Stainless
Metal - Granite

Quantity: 3

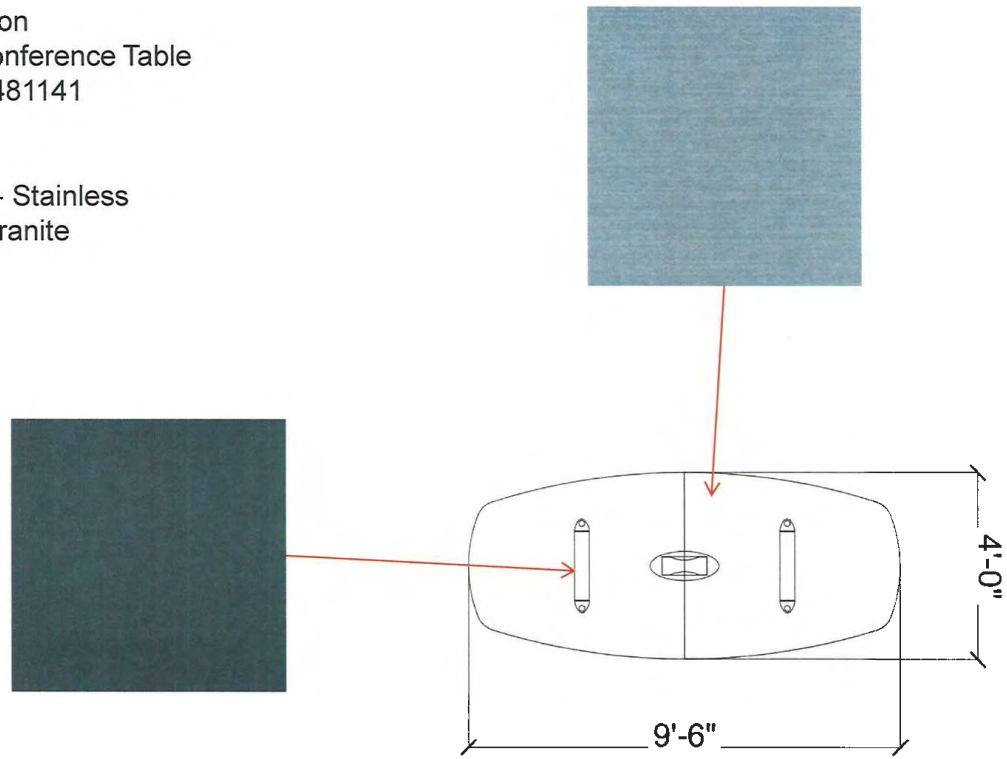

Boone County 911 Center Tables

Manufacturer: OFS

Style: Meeting Room Table & Base

Model #: Table Top - CT3-42-4G 1 MHM EM QR

Base - CB-04 1 MHM

Code: T6

Finishes: Honey Maple

Quantity: 2

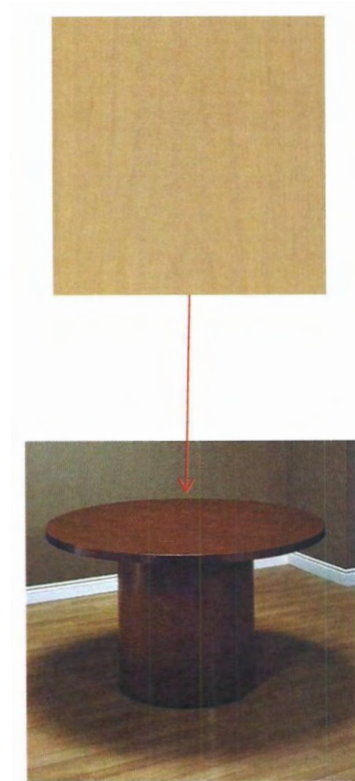

Boone County 911 Center Tables

Manufacturer: Brill
Style: End Table
Model #: 5130
Code: T7

Finishes: Pecan Finish on Oak #201

Quantity: 4



Boone County 911 Center Tables

Manufacturer: OFS
Style: Calypso End Table
Model #: C06-2424CT MHM
Code: T8

Finishes: Honey Maple

Quantity: 2

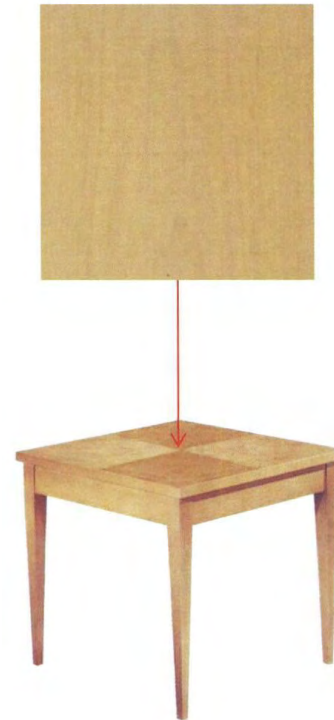

Boone County 911 Center Tables

Manufacturer: OFS
Style: Calypso Coffee Table
Model #: C06-4222MT MHM
Code: T9

Finishes: Honey Maple

Quantity: 1

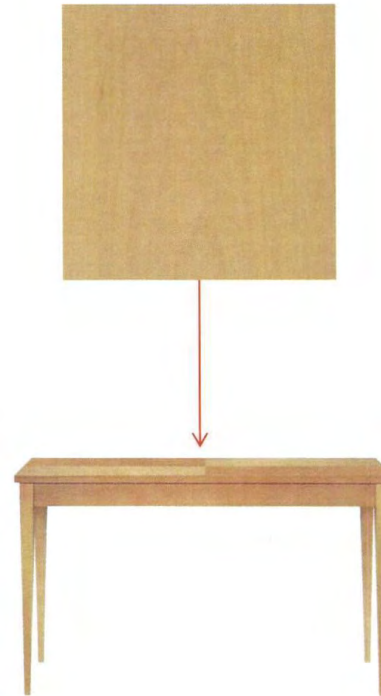

Boone County 911 Center Tables

Manufacturer: KI
Style: All Terrain Mobile Instructors Desk
Model #: ATMTD2454-74P-S2
Code: T10

Finishes: Laminate - Canyon Zephyr
Metal - Starlight Silver
Edge - Warm Grey

Quantity: 1

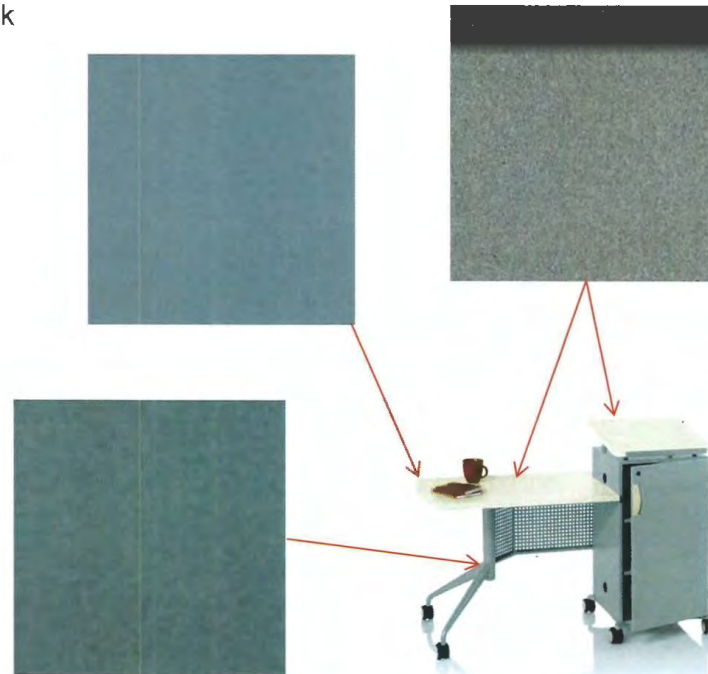

Boone County 911 Center Accessories

Manufacturer: Teknion
Style: Mast Dual Flat Panel Monitor Arms
Model #: YMSTM211Y
Code: E1

Finishes: Silver

Quantity: 26



Boone County 911 Center Accessories

Manufacturer: Teknion
Style: Keyboard Tray
Model #: YKT1B1
Code: E2

Finishes: Silver

Quantity: 26



Boone County 911 Center Accessories

Manufacturer: Teknion
Style: CPU Holder
Model #: YKCU1
Code: E3

Finishes: Silver

Quantity: 42



Boone County 911 Center Accessories

Manufacturer: Electri-Cable Assemblies
Style: Seclusion USB Series – 3 Power/2 USB
Model #: SECL-3-USB-GW72
Code: E4

Finishes: White

Quantity: 26

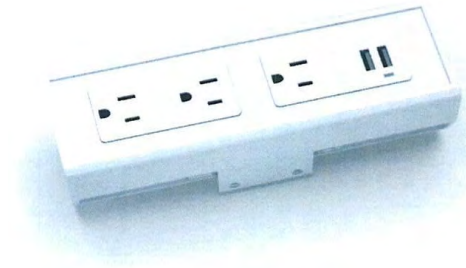

Boone County 911 Center Accessories

Manufacturer: Light Corp
Style: Reed Premier
Model #: RP.44.SO.PS60
Code: E5

Finishes: White

Quantity: 26



Boone County 911 Center Storage

Manufacturer: Teknion
Style: Ledger Lateral File
Model #: LLF40L1836D1A/W2
Code: F1

Finishes: Granite

Quantity: 4

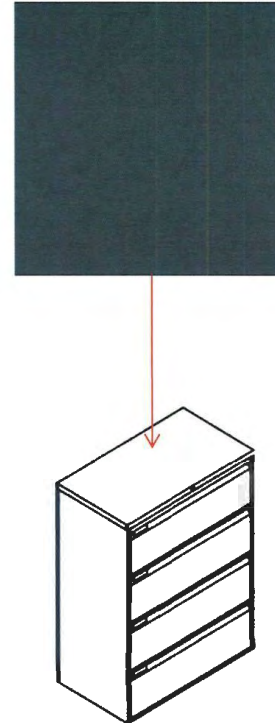

Boone County 911 Center Storage

Manufacturer: Teknion
Style: Ledger Lateral File
Model #: LLF40L1830D1A/W2
Code: F2

Finishes: Granite

Quantity: 4

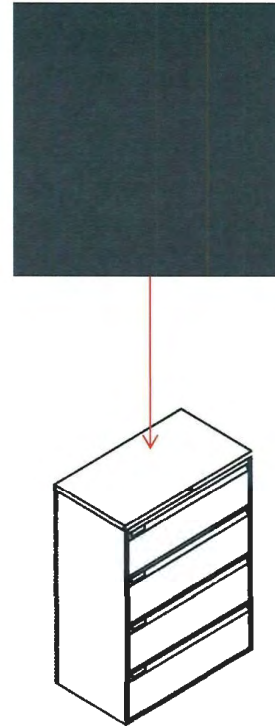

Boone County 911 Center Bedding

Manufacturer: Brill
Style: EZ Loft Single Beds
Model #: 3134
Code: O1

Finishes: Pecan Finish on Oak

Quantity: 12



Boone County 911 Center
Bedding

Manufacturer: Norix
Style: Twin Mattress
Model #: MNF6-3680
Code: O2

Finishes: N/A

Quantity: 12



**Boone County 911 Center
Bedding**

Manufacturer: Brill
Style: iTrek Metal Night Stand Shelf
Model #: BBF96-006
Code: O3

Finishes: Arctic Silver Powdercoat

Quantity: 6



STATEMENT OF BIDDER'S QUALIFICATIONS

Each bidder, for the work included in the specifications and plans and the Contract Documents, shall submit with their bid the data requested in the following schedule of information. This data must be included in and made a part of each bid document and be contained in the sealed envelope. Failure to comply with this instruction may be regarded as justification for rejecting the Contractor's proposal.

1. Name of Bidder: _____
2. Business Address: _____
3. When Organized: _____
4. When Incorporated: _____
5. List federal tax identification number: _____. If not incorporated, state type of business (sole proprietor, partnership, or other): _____. Fed tax ID or SS number: _____.
6. Number of years engaged in business under present firm name: _____
7. If you have done business under a *different name*, please give name and business location under that name: _____
8. Percent of work done by own staff: _____
9. Have you ever failed to complete any work awarded to your company?
 Yes No
If yes, where and why? _____
10. Have you ever defaulted on a contract or been in litigation for services performed?
 Yes No
If so, give details: _____

11. List of projects currently in progress: _____

12. List of contracts *with contact information*, completed within the last three (3) years, for similar services as described in this bid, including value of each: *Form provided on next page.*

*** Attach additional sheets as necessary ***

PRIOR EXPERIENCE

(References of similar services for governmental agencies are preferred)

Include references familiar with your company's work performance for metal roof replacements.

1. Prior Services Performed for:

Company Name:

Address:

Contact Name:

Telephone Number:

Date of Contract:

Length of Contract:

Description of Prior Services:

2. Prior Services Performed for:

Company Name:

Address:

Contact Name:

Telephone Number:

Date of Contract:

Length of Contract:

Description of Prior Services:

3. Prior Services Performed for:

Company Name:

Address:

Contact Name:

Telephone Number:

Date of Contract:

Length of Contract:

Description of Prior Services:

INSTRUCTIONS FOR COMPLIANCE WITH HOUSE BILL 1549

House Bill 1549 addresses the Department of Homeland Security's and the Social Security Administration's E-Verify Program (Employment Eligibility Verification Program) that requires the County to verify "lawful presence" of individuals when we contract for work/service; verify that Contractor has programs to verify lawful presence of their employees when contracts exceed \$5,000; and a requirement for OSHA safety training for public works projects.

The County is required to obtain certification that the bidder awarded the attached contract participates in a federal work authorization program. To obtain additional information on the Department of Homeland Security's E-Verify program, go to:

<http://www.uscis.gov/e-verify>

Please complete and return form *Work Authorization Certification Pursuant to 285.530 RSMo* if your contract amount is in excess of \$5,000. **Attach to this form the first and last two pages of the *E-Verify Memorandum of Understanding* that you completed when enrolling.**

CERTIFICATION OF INDIVIDUAL BIDDER

Pursuant to Section 208.009 RSMo, any person applying for or receiving any grant, contract, loan, retirement, welfare, health benefit, post secondary education, scholarship, disability benefit, housing benefit or food assistance who is over 18 must verify their lawful presence in the United States. Please indicate compliance below. Note: A parent or guardian applying for a public benefit on behalf of a child who is citizen or permanent resident need not comply.

- _____1. I have provided a copy of documents showing citizenship or lawful presence in the United States. (Such proof may be a Missouri driver’s license, U.S. passport, birth certificate, or immigration documents). Note: If the applicant is an alien, verification of lawful presence must occur prior to receiving a public benefit.

- _____2. I do not have the above documents, but provide an affidavit (copy attached) which may allow for temporary 90 day qualification.

- _____3. I have provided a completed application for a birth certificate pending in the State of _____. Qualification shall terminate upon receipt of the birth certificate or determination that a birth certificate does not exist because I am not a United States citizen.

Applicant

Date

Printed Name

AFFIDAVIT
(Only Required for Individual Bidder Certification Option #2)

State of Missouri)
)SS.
County of _____)

I, the undersigned, being at least eighteen years of age, swear upon my oath that I am either a United States citizen or am classified by the United States government as being lawfully admitted for permanent residence.

Date

Signature

Social Security Number
or Other Federal I.D. Number

Printed Name

On the date above written _____ appeared before me and swore that the facts contained in the foregoing affidavit are true according to his/her best knowledge, information and belief.

Notary Public

My Commission Expires:

CERTIFICATION REGARDING
DEBARMENT, SUSPENSION, INELIGIBILITY AND VOLUNTARY EXCLUSION
LOWER TIER COVERED TRANSACTIONS

(Please complete and return with Bid)

This certification is required by the regulations implementing Executive Order 12549, Debarment and Suspension, 29 CFR Part 98 Section 98.510, Participants' responsibilities. The regulations were published as Part VII of the May 26, 1988, Federal Register (pages 19160-19211).

(BEFORE COMPLETING CERTIFICATION, READ INSTRUCTIONS FOR
CERTIFICATION)

- (1) The prospective recipient of Federal assistance funds certifies, by submission of this proposal, that neither it nor its principals are presently debarred, suspended, proposed for debarment, declared ineligible, or voluntarily excluded from participation in this transaction by any Federal department or agency.

- (2) Where the prospective recipient of Federal assistance funds is unable to certify to any of the statements in this certification, such prospective participant shall attach an explanation to this proposal.

Print Name and Title of Authorized Representative

Signature

Date

AFFIDAVIT OF COMPLIANCE WITH THE PREVAILING WAGE LAW

Before me, the undersigned Notary Public, in and for the County of _____

State of _____, personally came and appeared (name and title)

_____ of the (name of company)

_____ (a corporation) (a partnership) (a proprietorship) and after being duly sworn did depose and say that all provisions and requirements set out in Chapter 290 Sections 290.210 through and including 290.340, Missouri Revised Statutes, pertaining to the payment of wages to workmen employed on public works projects have been fully satisfied and there has been no exception to the full and complete compliance with said provisions and requirements and with Wage Determination NO. _____ issued by the Division of Labor Standards on the _____ day of _____ 20____, in carrying out the Contract and work in connection with

(name of project) _____ located at

(name of institution) _____ in _____ County,

Missouri and completed on the _____ day of _____, 20_____.

Signature

Subscribed and sworn to me this _____ day of _____,
20_____.

My commission expires _____, 20_____.

Notary Public

Note: This document to be returned by the awarded contractor at project completion.

STANDARD TERMS AND CONDITIONS - BOONE COUNTY, MISSOURI

1. Contractor shall comply with all applicable federal, state, and local laws and failure to do so, in County's sole discretion, shall give County the right to terminate this Contract.
2. Responses shall include all charges for packing, delivery, installation, etc., (unless otherwise specified) to the Boone County Department identified in the Request for Bid and/or Proposal.
3. The Boone County Commission has the right to accept or reject any part or parts of all bids, to waive technicalities, and to accept the offer the County Commission considers the most advantageous to the County. Boone County reserves the right to award this bid on an item-by-item basis, or an "all or none" basis, whichever is in the best interest of the County.
4. Bidders must use the bid forms provided for the purpose of submitting bids, must return the bid and bid sheets comprised in this bid, give the unit price, extended totals, and sign the bid. The Purchasing Director reserves the right, when only one bid has been received by the bid closing date, to delay the opening of bids to another date and time in order to revise specifications and/or establish further competition for the commodity or service required. The one (1) bid received will be retained unopened until the new Closing date, or at request of bidder, returned unopened for re-submittal at the new date and time of bid closing.
5. When products or materials of any particular producer or manufacturer are mentioned in our specifications, such products or materials are intended to be descriptive of type or quality and not restricted to those mentioned.
6. Do not include Federal Excise Tax or Sales and Use Taxes in bid process, as law exempts the County from them.
7. The delivery date shall be stated in definite terms, as it will be taken into consideration in awarding the bid.
8. The County Commission reserves the right to cancel all or any part of orders if delivery is not made or work is not started as guaranteed. In case of delay, the Contractor must notify the Purchasing Department.
9. In case of default by the Contractor, the County of Boone will procure the articles or services from other sources and hold the Bidder responsible for any excess cost occasioned thereby.
10. Failure to deliver as guaranteed may disqualify Bidder from future bidding.
11. Prices must be as stated in units of quantity specified, and must be firm. Bids qualified by escalator clauses may not be considered unless specified in the bid specifications.

12. No bid transmitted by fax machine or e-mail will be accepted.
13. The County of Boone, Missouri expressly denies responsibility for, or ownership of any item purchased until same is delivered to the County and is accepted by the County.
14. The County reserves the right to award to one or multiple bidders. The County also reserves the right to not award any item or group of items if the services can be obtained from a state or other governmental entities contract under more favorable terms.
15. The County, from time to time, uses federal grant funds for the procurement of goods and services. Accordingly, the provider of goods and/or services shall comply with federal laws, rules and regulations applicable to the funds used by the County for said procurement, and contract clauses required by the federal government in such circumstances are incorporated herein by reference. These clauses can generally be found in the Federal Transit Administration's Best Practices Procurement Manual – Appendix A. Any questions regarding the applicability of federal clauses to a particular bid should be directed to the Purchasing Department prior to bid opening.
16. In the event of a discrepancy between a unit price and an extended line item price, the unit price shall govern.
17. Should an audit of Contractor's invoices during the term of the Agreement, and any renewals thereof, indicate that the County has remitted payment on invoices that constitute an over-charging to the County above the pricing terms agreed to herein, the Contractor shall issue a refund check to the County for any over-charges within 30-days of being notified of the same.
18. **For all titled vehicles and equipment the dealer must use the actual delivery date to the County on all transfer documents** including the Certificate of Origin (COO,) Manufacturer's Statement of Origin (MSO,) Bill of Sale (BOS,) and Application for Title.
19. **Equipment and serial and model numbers** - The Contractor is strongly encouraged to include equipment serial and model numbers for all amounts invoiced to the County. If equipment serial and model numbers are not provided on the face of the invoice, such information may be required by the County before issuing payment.



BOONE COUNTY PURCHASING
613 East Ash Street, Room 110
Columbia, MO 65201

NO BID RESPONSE FORM

Melinda Bobbitt, CPPO, CPPB
Director of Purchasing
Phone: (573) 886-4391
Fax: (573) 886-4390
mbobbitt@boonecountymo.org

BID INFORMATION:

Bid Number: 30-19MAY16

Bid Title: Office Furniture for the Emergency Communications Center

If you do not wish to respond to this bid request, but would like to remain on the Boone County vendor list **for this service/commodity**, please complete this form and return to the Purchasing Department by mail, fax, or email.

NOTE: COMPLETE AND RETURN THIS FORM ONLY IF YOU DO NOT WANT TO SUBMIT A BID.

Business Name: _____

Address: _____

Telephone: _____

Contact: _____

Date: _____

Reason(s) for not bidding:

AWS22 01/22/16

Missouri Division of Labor Standards

WAGE AND HOUR SECTION

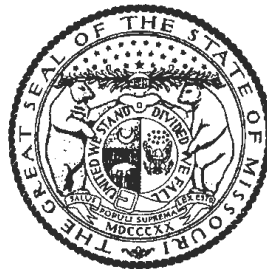

JEREMIAH W. (JAY) NIXON, Governor

Annual Wage Order No. 22

Section 010
BOONE COUNTY

In accordance with Section 290.262 RSMo 2000, within thirty (30) days after a certified copy of this Annual Wage Order has been filed with the Secretary of State as indicated below, any person who may be affected by this Annual Wage Order may object by filing an objection in triplicate with the Labor and Industrial Relations Commission, P.O. Box 599, Jefferson City, MO 65102-0599. Such objections must set forth in writing the specific grounds of objection. Each objection shall certify that a copy has been furnished to the Division of Labor Standards, P.O. Box 449, Jefferson City, MO 65102-0449 pursuant to 8 CSR 20-5.010(1). A certified copy of the Annual Wage Order has been filed with the Secretary of State of Missouri.

Original Signed by

John E. Lindsey, Director
Division of Labor Standards

This Is A True And Accurate Copy Which Was Filed With The Secretary of State: March 10, 2015

Last Date Objections May Be Filed: April 9, 2015

Prepared by Missouri Department of Labor and Industrial Relations

OCCUPATIONAL TITLE	** Date of Increase	*	Basic Hourly Rates	Over-Time Schedule	Holiday Schedule	Total Fringe Benefits
Asbestos Worker (H & F) Insulator	1/16		\$32.36	55	60	\$21.41
Boilermaker	8/15		\$34.76	57	7	\$28.00
Bricklayer and Stone Mason	6/15		\$28.95	59	7	\$15.25
Carpenter	6/15		\$24.75	60	15	\$15.55
Cement Mason	6/15		\$26.83	9	3	\$11.95
Communication Technician	6/15		\$31.35	28	7	\$12.70 + 13%
Electrician (Inside Wireman)	6/15		\$31.35	28	7	\$12.70 + 13%
Electrician (Outside-Line Construction) Lineman	9/15		\$42.52	43	45	\$5.00 + 36.5%
Lineman Operator	9/15		\$36.70	43	45	\$5.00 + 36.5%
Groundman	9/15		\$28.38	43	45	\$5.00 + 36.5%
Elevator Constructor		a	\$44.37	26	54	\$28.385
Glazier	10/15		\$26.67	122	76	\$11.33
Ironworker	8/15		\$28.41	11	8	\$24.04
Laborer (Building)						
General			\$21.71	42	44	\$12.84
First Semi-Skilled			\$23.71	42	44	\$12.84
Second Semi-Skilled			\$22.71	42	44	\$12.84
Lather			USE CARPENTER RATE			
Linoleum Layer and Cutter	8/15		\$24.63	60	15	\$15.55
Marble Mason	10/15		\$21.66	124	74	\$12.68
Marble Finisher	10/15		\$14.14	124	74	\$9.08
Millwright	6/15		\$25.75	60	15	\$15.55
Operating Engineer						
Group I	6/15		\$28.66	86	66	\$24.01
Group II	6/15		\$28.66	86	66	\$24.01
Group III	6/15		\$27.41	86	66	\$24.01
Group III-A	6/15		\$28.66	86	66	\$24.01
Group IV	6/15		\$26.43	86	66	\$24.01
Group V	6/15		\$29.36	86	66	\$24.01
Painter	6/15		\$22.94	18	7	\$11.33
Pile Driver	6/15		\$25.75	60	15	\$15.55
Pipe Fitter	7/15	b	\$37.00	91	69	\$26.68
Plasterer	6/15		\$25.40	94	5	\$12.00
Plumber	7/15	b	\$37.00	91	69	\$26.68
Roofer \ Waterproofer	10/15		\$29.30	12	4	\$14.87
Sheet Metal Worker	7/15		\$31.14	40	23	\$16.24
Sprinkler Fitter - Fire Protection	6/15		\$32.39	33	19	\$19.05
Terrazzo Worker			\$28.73	124	74	\$14.38
Terrazzo Finisher			\$18.68	124	74	\$14.38
Tile Setter	10/15		\$21.66	124	74	\$12.68
Tile Finisher	10/15		\$14.14	124	74	\$9.08
Traffic Control Service Driver			\$26.415	22	55	\$9.045
Truck Driver-Teamster						
Group I			\$25.30	101	5	\$10.70
Group II			\$25.95	101	5	\$10.70
Group III			\$25.45	101	5	\$10.70
Group IV			\$25.95	101	5	\$10.70

Fringe Benefit Percentage is of the Basic Hourly Rate

**Annual Incremental Increase

**REPLACEMENT PAGE
BOONE COUNTY
BUILDING CONSTRUCTION OVERTIME SCHEDULE**

FED: Minimum requirement per Fair Labor Standards Act means time and one-half (1 ½) shall be paid for all work in excess of forty (40) hours per work week.

NO. 9: Means the regular workday starting time of 8:00 a.m. (and resulting quitting time of 4:30 p.m.) may be moved forward to 6:00 a.m. or delayed one hour to 9:00 a.m. All work performed in excess of the regular work day and on Saturday shall be compensated at one and one-half (1½) times the regular pay. In the event time is lost during the work week due to weather conditions, the Employer may schedule work on the following Saturday at straight time. All work accomplished on Sunday and holidays shall be compensated for at double the regular rate of wages. The work week shall be Monday through Friday, except for midweek holidays.

NO. 11: Means eight (8) hours shall constitute a day's work, with the starting time to be established between 6:00 a.m. and 8:00 a.m. from Monday to Friday. Time and one-half (1½) shall be paid for first two (2) hours of overtime Monday through Friday and the first eight (8) hours on Saturday. All other overtime hours Monday through Saturday shall be paid at double (2) time rate. Double (2) time shall be paid for all time on Sunday and recognized holidays or the days observed in lieu of these holidays.

NO. 12: Means the work week shall commence on Monday at 12:01 a.m. and shall continue through the following Friday, inclusive of each week. All work performed by employees anywhere in excess of forty (40) hours in one (1) work week, shall be paid for at the rate of one and one-half (1½) times the regular hourly wage scale. All work performed within the regular working hours which shall consist of a ten (10) hour work day except in emergency situations. Overtime work and Saturday work shall be paid at one and one-half (1½) times the regular hourly rate. Work on recognized holidays and Sundays shall be paid at two (2) times the regular hourly rate.

NO. 18: Means the regular work day shall be eight (8) hours. Working hours are from six (6) hours before Noon (12:00) to six (6) hours after Noon (12:00). The regular work week shall be forty (40) hours, beginning between 6:00 a.m. and 12:00 Noon on Monday and ending between 1:00 p.m. and 6:00 p.m. on Friday. Saturday will be paid at time and one-half (1½). Sunday and Holidays shall be paid at double (2) time. Saturday can be a make-up day if the weather has forced a day off, but only in the week of the day being lost. Any time before six (6) hours before Noon or six (6) hours after Noon will be paid at time and one-half (1½).

NO. 22: Means a regular work week of forty (40) hours will start on Monday and end on Friday. The regular work day shall be either eight (8) or ten (10) hours. If a crew is prevented from working forty (40) hours Monday through Friday, or any part thereof by reason of inclement weather, Saturday or any part thereof may be worked as a make-up day at the straight time rate. Employees who are part of a regular crew on a make-up day, notwithstanding the fact that they may not have been employed the entire week, shall work Saturday at the straight time rate. A workday is to begin between 6:00 a.m. and 9:00 a.m. However, the project starting time may be advanced or delayed if mutually agreed to by the interest parties. For all time worked on recognized holidays, or days observed as such, double (2) time shall be paid.

NO. 26: Means that the regular working day shall consist of eight (8) hours worked between 6:00 a.m., and 5:00 p.m., five (5) days per week, Monday to Friday, inclusive. Hours of work at each jobsite shall be those established by the general contractor and worked by the majority of trades. (The above working hours may be changed by mutual agreement). Work performed on Construction Work on Saturdays, Sundays and before and after the regular working day on Monday to Friday, inclusive, shall be classified as overtime, and paid for at double (2) the rate of single time. The employer may establish hours worked on a jobsite for a four (4) ten (10) hour day work week at straight time pay for construction work; the regular working day shall consist of ten (10) hours worked consecutively, between 6:00 a.m. and 6:00 p.m., four (4) days per week, Monday to Thursday, inclusive. Any work performed on Friday, Saturday, Sunday and holidays, and before and after the regular working day on Monday to Thursday where a four (4) ten (10) hour day workweek has been established, will be paid at two times (2) the single time rate of pay. The rate of pay for all work performed on holidays shall be at two times (2) the single time rate of pay.

**REPLACEMENT PAGE
BOONE COUNTY
BUILDING CONSTRUCTION OVERTIME SCHEDULE**

NO. 28: Means a regular workday shall consist of eight (8) hours between 7:00 a.m. and 5:30 p.m., with at least a thirty (30) minute period to be taken for lunch. Five (5) days a week, Monday through Friday inclusive, shall constitute a work week. The Employer has the option for a workday/workweek of four (4) ten (10) hour days (4-10's) provided:

- The project must be for a minimum of four (4) consecutive days.
- Starting time may be within one (1) hour either side of 8:00 a.m.
- Work week must begin on either a Monday or Tuesday: If a holiday falls within that week it shall be a consecutive work day. (Alternate: If a holiday falls in the middle of a week, then the regular eight (8) hour schedule may be implemented).
- Any time worked in excess of any ten (10) hour work day (in a 4-10 hour work week) shall be at the appropriate overtime rate.

All work outside of the regular working hours as provided, Monday through Saturday, shall be paid at one & one-half (1½) times the employee's regular rate of pay. All work performed from 12:00 a.m. Sunday through 8:00 a.m. Monday and recognized holidays shall be paid at double (2) the straight time hourly rate of pay. Should employees work in excess of twelve (12) consecutive hours they shall be paid double time (2X) for all time after twelve (12) hours. Shift work performed between the hours of 4:30 p.m. and 12:30 a.m. (second shift) shall receive eight (8) hours pay at the regular hourly rate of pay plus ten (10%) percent for seven and one-half (7½) hours work. Shift work performed between the hours of 12:30 a.m. and 8:00 a.m. (third shift) shall receive eight (8) hours pay at the regular hourly rate of pay plus fifteen (15%) percent for seven (7) hours work. A lunch period of thirty (30) minutes shall be allowed on each shift. All overtime work required after the completion of a regular shift shall be paid at one and one-half (1½) times the shift hourly rate.

NO. 33: Means the standard work day and week shall be eight (8) consecutive hours of work between the hours of 6:00 a.m. and 6:00 p.m., excluding the lunch period Monday through Friday, or shall conform to the practice on the job site. Four (4) days at ten (10) hours a day may be worked at straight time, Monday through Friday and need not be consecutive. All overtime, except for Sundays and holidays shall be at the rate of time and one-half (1½). Overtime worked on Sundays and holidays shall be at double (2) time.

NO. 40: Means the regular working week shall consist of five (5) consecutive (8) hour days' labor on the job beginning with Monday and ending with Friday of each week. Four (4) 10-hour days may constitute the regular work week. The regular working day shall consist of eight (8) hours labor on the job beginning as early as 6:00 a.m. and ending as late as 5:30 p.m. All full or part time labor performed during such hours shall be recognized as regular working hours and paid for at the regular hourly rate. All hours worked on Saturday and all hours worked in excess of eight (8) hours but not more than twelve (12) hours during the regular working week shall be paid for at time and one-half (1½) the regular hourly rate. All hours worked on Sundays and holidays and all hours worked in excess of twelve (12) hours during the regular working day shall be paid at two (2) times the regular hourly rate. In the event of rain, snow, cold or excessively windy weather on a regular working day, Saturday may be designated as a "make-up" day. Saturday may also be designated as a "make-up" day, for an employee who has missed a day of work for personal or other reasons. Pay for "make-up" days shall be at regular rates.

**REPLACEMENT PAGE
BOONE COUNTY
BUILDING CONSTRUCTION OVERTIME SCHEDULE**

NO. 42: Means eight (8) hours between the hours of 8:00 a.m. and 4:30 p.m. shall constitute a work day. The starting time may be advanced one (1) or two (2) hours. Employees shall have a lunch period of thirty (30) minutes. The Employer may provide a lunch period of one (1) hour, and in that event, the workday shall commence at 8:00 a.m. and end at 5:00 p.m. The workweek shall commence at 8:00 a.m. on Monday and shall end at 4:30 p.m. on Friday (or 5:00 p.m. on Friday if the Employer grants a lunch period of one (1) hour), or as adjusted by starting time change as stated above. All work performed before 8:00 a.m. and after 4:30 p.m. (or 5:00 p.m. where one (1) hour lunch is granted for lunch) or as adjusted by starting time change as stated above or on Saturday, except as herein provided, shall be compensated at one and one-half (1½) times the regular hourly rate of pay for the work performed. All work performed on Sunday and on recognized holidays shall be compensated at double (2) the regular hourly rate of pay for the work performed. When working a five 8-hour day schedule and an Employer is prevented from working forty (40) hours, Monday through Friday, or any part thereof by reason of inclement weather (rain or mud), Saturday or any part thereof may be worked as a make-up day at the straight time rate. The Employer shall have the option of working five eight (8) hour days or four ten (10) hour days Monday through Friday. If an Employer elects to work five (5) eight (8) hour days during any work week, hours worked more than eight (8) per day or forty (40) hours per week shall be paid at time and one-half (1½) the hourly rate Monday through Friday. If an Employer elects to work four (4) ten (10) hour days in any week, work performed more than ten (10) hours per day or forty (40) hours per week shall be paid at time and one-half (1½) the hourly rate Monday through Friday. If an Employer is working ten (10) hour days and loses a day due to inclement weather, they may work ten (10) hours Friday at straight time. All hours worked over the forty (40) hours Monday through Friday will be paid at time and one-half (1½) overtime rate. Overtime shall be computed at half-hour intervals. Shift Work: Two (2) or three (3) shifts shall be permitted, provided such shifts are scheduled for a minimum of three (3) consecutive days. The second shift shall begin at 4:30 p.m. and end at 12:30 a.m. with one-half (1/2) hour for lunch between 7:30 p.m. and 9:00 p.m. and shall received eighty (8) hours' pay. The third shift shall begin at 12:30 a.m. and end at 8:00 a.m. with one-half (1/2) hour for lunch between 3:30 a.m. and 5:00 a.m. and shall received (8) hours' pay. There shall be at least one (1) foreman on each shift on jobs where more than one shift is employed, provided that there are two (2) or more employees on second and on the third shifts. All shifts shall arrange to interchange working hours at the end of each week. When three shifts are used, the applicable rate must be paid from Saturday at 8:00 a.m. until the following Monday at 8:00 a.m. When three shifts are employed, the second and third shifts shall contain at least one-half (1/2) as many employees as the first shift.

NO. 43: Eight (8) hours shall constitute a work day between the hours of 7:00 a.m. and 4:30 p.m. Forty (40) hours within five (5) days, Monday through Friday inclusive, shall constitute the work week. Work performed in the 9th and 10th hour, Monday through Friday, shall be paid at time and one-half (1½) the regular straight time rate of pay. Contractor has the option to pay two (2) hours per day at the time and one-half (1½) the regular straight time rate of pay between the hours of 6:00 a.m. and 5:30 p.m., Monday through Friday. Work performed outside the regularly scheduled working hours and on Saturdays, Sundays and recognized legal holidays, or days celebrated as such, shall be paid for at the rate of double (2) time.

NO. 55: Means the regular work day shall be eight (8) hours between 6:00 a.m. and 4:30 p.m. The first two (2) hours of work performed in excess of the eight (8) hour work day, Monday through Friday, and the first ten (10) hours of work on Saturday, shall be paid at one & one-half (1½) times the straight time rate. All work performed on Sunday, observed holidays and in excess of ten (10) hours a day, Monday through Saturday, shall be paid at double (2) the straight time rate.

NO. 57: Means eight (8) hours per day shall constitute a day's work and forty (40) hours per week, Monday through Friday, shall constitute a week's work. The regular starting time shall be 8:00 a.m. If a second or third shift is used, the regular starting time of the second shift shall be 4:30 p.m. and the regular starting period for the third shift shall be 12:30 a.m. These times may be adjusted by the employer. The day shift shall work a regular eight (8) hours shift as outlined above. Employees working a second shift shall receive an additional \$0.25 above the regular hourly rate and perform seven and one-half (7½) hours work for eight (8) hours pay. Third shift employees shall be paid an additional \$0.50 above the regular hourly rate and work seven (7) hours for eight (8) hours pay. When circumstances warrant, the Employer may change the regular workweek to four (4) ten-hour days at the regular time rate of pay. All time worked before and after the established workday of eight (8) hours, Monday through Friday, and all time worked on Saturday shall be paid at the rate of time and one-half (1½) except in cases where work is part of an employee's regular Friday shift. All time worked on Sunday and recognized holidays shall be paid at the double (2) time rate of pay except in cases where work is part of an employee's previous day's shift. For all overtime hours worked \$26.71 of the fringe benefits portion of the prevailing wage shall be paid at the same overtime rate at which the cash portion of the prevailing wage is to be paid. The remaining \$1.29 of the fringe benefit portion of the prevailing wage may be paid at straight time.

**REPLACEMENT PAGE
BOONE COUNTY
BUILDING CONSTRUCTION OVERTIME SCHEDULE**

NO. 59: Means that except as herein provided, eight (8) hours a day shall constitute a standard work day, and forty (40) hours per week shall constitute a week's work. All time worked outside of the standard eight (8) hour work day and on Saturday shall be classified as overtime and paid the rate of time and one-half (1½). All time worked on Sunday and holidays shall be classified as overtime and paid at the rate of double (2) time. The Employer has the option of working either five (5) eight hour days or four (4) ten hour days to constitute a normal forty (40) hour work week. When the four (4) ten-hour work week is in effect, the standard work day shall be consecutive ten (10) hour periods between the hours of 6:30 a.m. and 6:30 p.m. Forty (40) hours per week shall constitute a week's work, Monday through Thursday, inclusive. In the event the job is down for any reason beyond the Employer's control, then Friday and/or Saturday may, at the option of the Employer, be worked as a make-up day; straight time not to exceed ten (10) hours or forty (40) hours per week. When the five day eight (8) hour work week is in effect, forty (40) hours per week shall constitute a week's work, Monday through Friday, inclusive. In the event the job is down for any reason beyond the Employer's control, then Saturday may, at the option of the Employer, be worked as a make-up day; straight time not to exceed eight (8) hours or forty (40) hours per week. The regular starting time (and resulting quitting time) may be moved to 6:00 a.m. or delayed to 9:00 a.m. Make-up days shall not be utilized for days lost due to holidays.

NO. 60: Means the Employer shall have the option of working five 8-hour days or four 10-hour days Monday through Friday. If an Employer elects to work five 8-hour days during any work week, hours worked more than eight (8) per day or forty (40) per week shall be paid at time and one-half (1½) the hourly wage rate plus fringe benefits Monday through Friday. **SATURDAY MAKE-UP DAY:** If an Employer is prevented from working forty (40) hours, Monday through Friday, or any part thereof by reason of inclement weather (rain or mud), Saturday or any part thereof may be worked as a make-up day at the straight time rate. It is agreed by the parties that the make-up day is not to be used to make up time lost due to recognized holidays. If an Employer elects to work four 10-hour days, between the hours of 6:30 a.m. and 6:30 p.m. in any week, work performed more than ten (10) hours per day or forty (40) hours per week shall be paid at time and one half (1½) the hourly wage rate plus fringe benefits Monday through Friday. If an Employer is working 10-hour days and loses a day due to inclement weather, the Employer may work ten (10) hours on Friday at straight time. All hours worked over the forty (40) hours Monday through Friday will be paid at time and one-half (1½) the hourly wage rate plus fringe benefits. All Millwright work performed in excess of the regular work day and on Saturday shall be compensated for at time and one-half (1½) the regular Millwright hourly wage rate plus fringe benefits. The regular work day starting at 8:00 a.m. (and resulting quitting time of 4:30 p.m.) may be moved forward to 6:00 a.m. or delayed one (1) hour to 9:00 a.m. All work accomplished on Sundays and recognized holidays, or days observed as recognized holidays, shall be compensated for at double (2) the regular hourly rate of wages plus fringe benefits. NOTE: All overtime is computed on the hourly wage rate plus an amount equal to the fringe benefits.

NO. 86: The regular workday shall consist of eight (8) consecutive hours, exclusive of a thirty (30) minute lunch period, with pay at the straight time rate with all hours in excess of eight (8) hours in any one day to be paid at the applicable overtime rate at time and one-half (1½). The regular workday shall begin between the hours of 6:00 a.m. and 8:00 a.m. The Employer may have the option to schedule the work week from Monday through Thursday at ten (10) hours per day at the straight time rate of pay with all hours in excess of ten (10) hours in any one day to be paid at the applicable overtime rate at time and one-half (1½). If the Employer elects to work from Monday through Thursday and is stopped due to inclement weather, holiday or other conditions beyond the control of the Employer, they shall have the option to work Friday at the straight time rate of pay to complete the forty (40) hours for the workweek. All overtime work performed on Monday through Saturday shall be paid at time and one-half (1½) the hourly rate. Fringe benefits shall be paid at the one and one half the hourly rate. All work performed on Sundays and recognized holidays shall be paid at double (2) the hourly rate. Fringe benefits shall be paid at double the hourly rate. Shifts may be established when considered necessary by the Employer. Shift hours and rates will be as follows. If shifts are established, work on the First Shift will begin between 6:00 a.m. and 9:00 a.m. and consist of eight (8) hours of work plus one-half hour unpaid lunch. Hours worked during the first shift will be paid at the straight time rate of pay. The second shift shall start eight hours after the start of the first shift and consist of eight (8) hours of work plus one-half hour unpaid lunch. Work on the second shift will begin between 2:00 p.m. and 5:00 p.m. and be paid the straight time rate plus \$2.50 per hour. The third shift shall start eight hours after the start of the second shift and consist of eight (8) hours plus one-half hour unpaid lunch. Work on the third shift will begin between 10:00 p.m. and 1:00 a.m. and be paid the straight time rate plus \$3.50 per hour. The additional amounts that are to be paid are only applicable when working shifts. Shifts that begin on Saturday morning through those shifts which end on Sunday morning will be paid at time and one-half these rates. Shifts that begin on Sunday morning through those shifts which end on Monday morning will be paid at double time these rates.

**REPLACEMENT PAGE
BOONE COUNTY
BUILDING CONSTRUCTION OVERTIME SCHEDULE**

NO. 87: Means eight (8) hours starting between 6:00 a.m. and 8:00 a.m. and ending between 2:30 p.m. and 4:30 p.m. at the Employers discretion shall constitute a day's work. Any work prior to 6:00 a.m. or after eight (8) hours shall be paid at the overtime rate. Five (5) days from Monday through Friday inclusive shall constitute a regular work week. All hours before and after these regular hours shall be considered overtime and shall be paid for at the rate of double (2) time. All work on Saturday and Sunday shall be paid at double (2) the prevailing scale of wages.

NO. 91: Means eight (8) hours shall constitute a day's work commencing at 7:00 a.m. and ending at 3:30 p.m., allowing one-half (½) hour for lunch. The option exists for the Employer to use a flexible starting time between the hours of 6:00 a.m. and 9:00 a.m. The regular workweek shall consist of forty (40) hours of five (5) workdays, Monday through Friday. The workweek may consist of four (4) ten (10) hour days from Monday through Thursday, with Friday as a make-up day. If the make-up day is a holiday, the employee shall be paid at the double (2) time rate. The employees shall be paid time and one-half (1½) for work performed on Saturdays, before the regular starting time or after the regular quitting time or over eight (8) hours per work day (unless working a 10-hour work day, then time and one-half (1½) is paid for work performed over ten (10) hours a day) or over forty (40) hours per work week. Work performed on Sundays and recognized holidays shall be paid at the double (2) time rate of pay. **SHIFT WORK:** When it is necessary for the project to operate in shifts, there will be three (3) eight (8) hour shifts commencing at 8:00 a.m. Shift work must continue for a period of not less than three (3) consecutive work days, two (2) days which must be regular work days (Monday through Friday). In the event the second or third shift of any regular work day shall fall into a Saturday or a holiday, such extension into a Saturday or holiday shall be considered as part of the previous workday and employees shall be paid at the regular shift rate. The first day shift shall work a regular eight (8) hour day at regular rates. The second shift shall be eight (8) hours regular time pay plus \$2.50 per hour premium for eight (8) hours work. Third shift will be for eight (8) hours regular time pay plus \$3.00 per hour premium for eight (8) hours work.

NO. 94: Means eight (8) hours shall constitute a day's work between the hours of 8:00 a.m. and 5:00 p.m. The regular workday starting time of 8:00 a.m. (and resulting quitting time of 4:30 p.m.) may be moved forward to 6:00 a.m. or delayed one (1) hour to 9:00 a.m. All work performed in excess of the regular work day and on Saturday shall be compensated at one and one-half (1½) times the regular pay. In the event time is lost during the work week due to weather conditions, the Employer may schedule work on the following Saturday at straight time. All work accomplished on Sunday and holidays shall be compensated at double the regular rate of wages.

NO. 101: Means that except as provided below, eight (8) hours a day shall constitute a standard work day, and forty (40) hours per week shall constitute a week's work, which shall begin on Monday and end on Friday. All time worked outside of the standard work day and on Saturday shall be classified as overtime and paid the rate of time and one-half (1½) (except as herein provided). All time worked on Sunday and recognized holidays shall be classified as overtime and paid at the rate of double (2) time. The regular starting time of 8:00 a.m. (and resulting quitting time of 4:30 p.m.) may be moved forward to 6:00 a.m. or delayed one (1) hour to 9:00 a.m. The Employer has the option of working either five (5) eight-hour days or four (4) ten-hour days to constitute a normal forty (40) hour work week. When a four (4) ten-hour day work week is in effect, the standard work day shall be consecutive ten (10) hour periods between the hours of 6:30 a.m. and 6:30 p.m. Forty (40) hours per week shall constitute a week's work Monday through Thursday, inclusive. In the event the job is down for any reason beyond the Employer's control, then Friday and/or Saturday may, at the option of the Employer, be worked as a make-up day; straight time not to exceed ten (10) hours per day or forty (40) hours per week. Starting time will be designated by the employer. When the five (5) day eight (8) hour work week is in effect, forty (40) hours per week shall constitute a week's work, Monday through Friday, inclusive. In the event the job is down for any reason beyond the Employer's control, then Saturday may, at the option of the Employer, be worked as a make-up day; straight time not to exceed eight (8) hours per day or forty (40) hours per week. Make-up days shall not be utilized for days lost due to holidays.

NO. 122: Means forty (40) hours between Monday and Friday shall constitute the normal work week. Work shall be scheduled between the hours of 6:00 a.m. and 6:30 p.m., with one-half hour for lunch. Work in excess of eight (8) hours per day and forty (40) hours per week, and on Saturdays, shall be paid at the rate of one and one-half times the normal rate. Due to inclement weather during the week, Saturday shall be a voluntary make up day.

**REPLACEMENT PAGE
BOONE COUNTY
BUILDING CONSTRUCTION OVERTIME SCHEDULE**

NO. 124: Means eight (8) hours shall constitute a day's work on all classes of work between the hours of 6:00 a.m. and 5:30 p.m., Monday through Friday. The pay for time worked during these hours shall be at the regular wage rate. The regular workweek shall be Monday through Friday. Employment from 4:30 p.m. to 12:00 midnight, Monday through Friday, shall be paid for at one and one-half (1½) times the regular hourly rate. From 12:00 midnight until 8:00 a.m. on any day shall be paid for at twice the regular hourly rate. All time worked on Sundays and the recognized holidays shall be paid at the rate of double (2) time. It is understood that forty (40) hours shall constitute a regular workweek, (5-8's) Sunday Midnight through Friday Midnight, understanding anything over eight (8) hours is one and one-half (1½) times the hourly wage rate.

**BOONE COUNTY
HOLIDAY SCHEDULE – BUILDING CONSTRUCTION**

NO. 3: All work done on New Year's Day, Decoration Day, July 4th, Labor Day, Veteran's Day, Thanksgiving and Christmas shall be compensated at the double (2) time rate of pay. When any of these holidays fall on a Sunday, the following Monday shall be observed.

NO. 4: All work done on New Year's Day, Memorial Day, Independence Day, Labor Day, Thanksgiving and Christmas Day shall be paid at the double time rate of pay. If any of the above holidays fall on Sunday, Monday will be observed as the recognized holiday. If any of the above holidays fall on Saturday, Friday will be observed as the recognized holiday.

NO. 5: All work that shall be done on New Year's Day, Memorial Day, Fourth of July, Labor Day, Veteran's Day, Thanksgiving Day, and Christmas Day shall be paid at the double (2) time rate of pay.

NO. 7: The following days are assigned days and are recognized as holidays: New Year's Day, Memorial Day, Independence Day, Labor Day, Veteran's Day, Thanksgiving Day, and Christmas Day. If a holiday falls on a Sunday, it shall be observed on the following Monday. If a holiday falls on a Saturday, it shall be observed on the preceding Friday. No work shall be performed on Labor Day except in case of jeopardy to work under construction. This is applied to protect Labor Day. When a holiday falls during the normal workweek, Monday through Friday, it shall be counted as eight (8) hours toward the forty (40) hour week. However, no reimbursement for these eight (8) hours is to be paid to the workman unless worked. If workman are required to work the above enumerated holidays or days observed as such, or on Sunday, they shall receive double (2) the regular rate of pay for such work.

NO. 8: All work performed on New Year's Day, Memorial Day, Independence Day, Labor Day, Veteran's Day, Thanksgiving Day, and Christmas Day, or the days observed in lieu of these holidays, shall be paid at the double time rate of pay.

NO. 15: All work accomplished on the recognized holidays of New Year's Day, Decoration Day (Memorial Day), Independence Day (Fourth of July), Labor Day, Veteran's Day, Thanksgiving Day and Christmas Day, or days observed as these named holidays, shall be compensated for at double (2) the regular hourly rate of wages plus fringe benefits. If a holiday falls on Saturday, it shall be observed on the preceding Friday. If a holiday falls on a Sunday, it shall be observed on the following Monday. No work shall be performed on Labor Day, Christmas Day, Decoration Day or Independence Day except to preserve life or property.

NO. 19: All work done on New Year's Day, Memorial Day, July 4th, Labor Day, Thanksgiving Day, and Christmas Day shall be paid at the double time rate of pay. The employee may take off Friday following Thanksgiving Day. However, the employee shall notify his or her Foreman, General Foreman or Superintendent on the Wednesday preceding Thanksgiving Day. When one of the above holidays falls on Sunday, the following Monday shall be considered a holiday and all work performed on either day shall be at the double (2) time rate. When one of the holidays falls on Saturday, the preceding Friday shall be considered a holiday and all work performed on either day shall be at the double (2) time rate.

NO. 23: All work done on New Year's Day, Memorial Day, Independence Day, Labor Day, Veteran's Day, Thanksgiving Day, Christmas Day and Sundays shall be recognized holidays and shall be paid at the double time rate of pay. When a holiday falls on Sunday, the following Monday shall be considered a holiday. When a holiday falls on Saturday, Friday is recognized as a holiday.

NO. 31: All work done on New Year's Day, Presidents Day, Good Friday, Memorial Day, Fourth of July, Labor Day, Veteran's Day, Thanksgiving Day, Friday after Thanksgiving Day, Christmas Day, and Employee's Birthday shall be paid at the double time rate of pay. If a holiday falls on Sunday, the following Monday will be observed as the recognized holiday. If a holiday falls on Saturday, the preceding Friday will be observed as the recognized holiday.

ANNUAL WAGE ORDER NO. 22

AWO22 010 BHol.doc

Page 1 of 2 Pages

**BOONE COUNTY
HOLIDAY SCHEDULE – BUILDING CONSTRUCTION**

NO. 44: All work done on New Year's Day, Memorial Day, Independence Day, Veteran's Day, Thanksgiving Day, and Christmas Day shall be paid at the double time rate of pay. If a holiday falls on a Sunday, it shall be observed on the Monday following. If a holiday falls on a Saturday, it shall be observed on the preceding Friday. No work shall be performed on these days except in emergency to protect life or property. All work performed on these holidays shall be compensated at double the regular hourly rate for the work performed. Overtime shall be computed at half-hour intervals.

NO. 45: All work performed on New Year's Day, Memorial Day, Independence Day, Labor Day, Veteran's Day, Thanksgiving Day, the day after Thanksgiving, the day before Christmas, and Christmas Day, shall be paid at the double time rate of pay.

NO. 54: All work performed on New Year's Day, Memorial Day, Independence Day, Labor Day, Veteran's Day, Thanksgiving Day, the Friday after Thanksgiving Day, and Christmas Day shall be paid at the double (2) time rate of pay. When a holiday falls on Saturday, it shall be observed on Friday. When a holiday falls on Sunday, it shall be observed on Monday.

NO. 55: The following days are recognized as holidays: New Year's Day, Memorial Day, Independence Day, Labor Day, Thanksgiving Day and Christmas Day. If a holiday falls on a Sunday, it shall be observed on the following Monday. No work shall be performed on Labor Day except in case of jeopardy to work under construction. This rule is applied to protect Labor Day. When a holiday falls during the normal work week, Monday through Friday, it shall be counted as eight (8) hours toward the forty (40) hour week; however, no reimbursement for this eight (8) hours is to be paid the workmen unless worked. An Employer working a four (4) day, ten (10) hour schedule may use Friday as a make up day when an observed holiday occurs during the work week. Employees have the option to work that make up day. If workmen are required to work the above enumerated holidays, or days observed as such, they shall receive double (2) the regular rate of pay for such work.

NO. 60: All work performed on New Year's Day, Armistice Day (Veteran's Day), Decoration Day (Memorial Day), Independence Day (Fourth of July), Thanksgiving Day and Christmas Day shall be paid at the double time rate of pay. No work shall be performed on Labor Day except when triple (3) time is paid. When a holiday falls on Saturday, Friday will be observed as the holiday. When a holiday falls on Sunday, the following Monday shall be observed as the holiday.

NO. 66: All work performed on Sundays and the following recognized holidays, or the days observed as such, of New Year's Day, Decoration Day, Fourth of July, Labor Day, Veteran's Day, Thanksgiving Day and Christmas Day, shall be paid at double (2) the hourly rate plus an amount equal to the hourly Total Indicated Fringe Benefits. Whenever any such holidays fall on a Sunday, the following Monday shall be observed as a holiday.

NO. 69: All work performed on New Year's Day, Memorial Day, July Fourth, Labor Day, Veteran's Day, Thanksgiving Day or Christmas Day shall be compensated at double (2) their straight-time hourly rate of pay. Friday after Thanksgiving and the day before Christmas are also holidays, however, if the employer chooses to work the normal work hours on these days, the employee will be paid at straight-time rate of pay. If a holiday falls on a Saturday, the holiday will be observed on Saturday; if a holiday falls on a Sunday, the holiday will be observed on the following Monday.

NO. 74: All work performed on New Year's Day, Memorial Day, Fourth of July, Labor Day, Veteran's Day, Thanksgiving Day and Christmas Day, shall be paid at double (2) time of the hourly rate of pay. In the event one of the above holiday's falls on Saturday, the holiday shall be celebrated on Saturday. If the holiday falls on Sunday, the holiday will be celebrated on Monday.

NO. 76: Work performed on Holidays shall be paid at the rate of two times the normal rate. Holidays are: New Years Day, Memorial Day, Independence Day, Labor Day, Thanksgiving Day, Day after Thanksgiving, Christmas Day. If a holiday falls on a Sunday, it shall be celebrated on the following Monday, if it falls on Saturday, it shall be celebrated on the preceding Friday.

OCCUPATIONAL TITLE	* Date of Increase	Basic Hourly Rates	Over-Time Schedule	Holiday Schedule	Total Fringe Benefits
Carpenter	6/15	\$30.41	23	16	\$15.55
Electrician (Outside-Line Construction)\Lineman	9/15	\$42.52	9	12	\$5.00 + 36.5%
Lineman Operator	9/15	\$36.70	9	12	\$5.00 + 36.5%
Lineman - Tree Trimmer	10/15	\$23.90	32	31	\$9.73 + 3%
Groundman	9/15	\$28.38	9	12	\$5.00 + 36.5%
Groundman - Tree Trimmer	10/15	\$17.64	32	31	\$7.72 + 3%
Laborer					
General Laborer	6/15	\$27.36	2	4	\$12.82
Skilled Laborer	6/15	\$27.36	2	4	\$12.82
Millwright	6/15	\$30.41	23	16	\$15.55
Operating Engineer					
Group I	6/15	\$27.74	21	5	\$23.91
Group II	6/15	\$27.39	21	5	\$23.91
Group III	6/15	\$27.19	21	5	\$23.91
Group IV	6/15	\$23.54	21	5	\$23.91
Oilier-Driver	6/15	\$23.54	21	5	\$23.91
Pile Driver	6/15	\$30.41	23	16	\$15.55
Traffic Control Service Driver		\$26.415	28	27	\$9.045
Truck Driver-Teamster					
Group I	6/15	\$28.87	25	21	\$12.05
Group II	6/15	\$29.03	25	21	\$12.05
Group III	6/15	\$29.02	25	21	\$12.05
Group IV	6/15	\$29.14	25	21	\$12.05

Use Heavy Construction Rates on Highway and Heavy construction in accordance with the classifications of construction work established in 8 CSR 30-3.040(3).

Use Building Construction Rates on Building construction in accordance with the classifications of construction work established in 8 CSR 30-3.040(2).

If a worker is performing work on a heavy construction project within an occupational title that is not listed on the Heavy Construction Rate Sheet, use the rate for that occupational title as shown on the Building Construction Rate sheet.

**REPLACEMENT PAGE
BOONE COUNTY
OVERTIME SCHEDULE - HEAVY CONSTRUCTION**

FED: Minimum requirement per Fair Labor Standards Act means time and one-half (1 ½) shall be paid for all work in excess of forty (40) hours per work week.

NO. 2: Means a regular workweek shall be forty (40) hours and will start on Monday and end on Friday. The Employer shall have the option of working five 8-hour days or four 10-hour days Monday through Friday. If an Employer elects to work five 8-hour days during any workweek, hours worked more than eight (8) per day or 40 per week shall be paid at time and one-half the hourly rate Monday through Friday. If an Employer elects to work four 10-hour days in a week, work performed more than ten (10) hours per day or 40 hours per week shall be paid at time and one-half the hourly rate Monday through Friday. When working a five 8-hour day schedule and an Employer is prevented from working forty (40) hours Monday through Friday, or any part thereof, by reason of inclement weather, Saturday or any part thereof may be worked as a make-up day at the straight time rate. If an Employer is working a four 10-hour day schedule and loses a day due to inclement weather, he may work 10 hours Friday at straight time. All hours worked over the 40 hours Monday through Friday will be paid at 1 ½ overtime rate. A workday shift is to begin at the option of the Employer, between 6:00 a.m. and not later than 9:00 a.m. However, the project starting time may be advanced or delayed if required. If workmen are required to work the enumerated holidays or days observed as such or Sundays, they shall receive double (2) the regular rate of pay for such work. Overtime shall be computed at one-half (1/2) hour intervals. Shift: The Contractor may elect to work one, two or three shifts on any work. When operating on more than one shift, the shifts shall be known as the day shift, swing shift, and graveyard shift as such terms are recognized in the industry. When two shifts are worked on any operation, the shifts will consist of eight (8) or ten (10) hours exclusive of lunchtime. When three shifts are worked the first day or day shift will consist of eight (8) hours exclusive of lunchtime. The second or swing shift shall consist of seven and one-half (7 1/2) hours work for eight hours pay, exclusive of lunchtime, and the third or the graveyard shift shall consist of seven (7) hours work for eight (8) hours pay, exclusive of the lunchtime. All time in excess of normal shifts shall be considered overtime. Multiple shift (the two or three shift) operation will not be construed on the entire project if at anytime it is deemed advisable and necessary for the Employer to multiple shift a specific operation. However, no shift shall be started between midnight and six a.m. except the graveyard shift on a three-shift operation, or except in an unusual or emergency situation. If an Employer starts a shift between midnight and 6 a.m. except the graveyard shift on a three-shift operation, he shall reimburse all employees for the entire shift at the double time rate. Completion of the second shift on a two-shift operation or completion of the graveyard shift on a three-shift operation that carries over into Saturday morning, shall be at the straight time rate. Overtime shall be computed at ½ hour intervals.

NO. 9: Eight (8) hours shall constitute a work day between the hours of 7:00 a.m. and 4:30 p.m. Forty (40) hours within five (5) days, Monday through Friday inclusive, shall constitute the work week. Work performed in the 9th and 10th hour, Monday through Friday, shall be paid at time and one-half (1½) the regular straight time rate of pay. Contractor has the option to pay two (2) hours per day at the time and one-half (1½) the regular straight time rate of pay between the hours of 6:00 a.m. and 5:30 p.m., Monday through Friday. Worked performed in the first eight (8) hours on Saturday shall be paid at the rate of one and eight tenths (1.8) the regular straight time rate. Work performed outside these hours and on Sundays and recognized legal holidays, or days celebrated as such, shall be paid for at the rate of double (2) time.

NO. 21: Means the regular workday for which employees shall be compensated at straight time hourly rate of pay shall, unless otherwise provided for, begin at 8:00 a.m. and end at 4:30 p.m. However, the project starting time may be advanced or delayed at the discretion of the Employer. At the discretion of the Employer, when working a five (5) day eight (8) hour schedule, Saturday may be used for a make-up day. If an Employer is prohibited from working on a holiday, that employer may work the following Saturday at the straight time rate. However, the Employer may have the option to schedule his work from Monday through Thursday at ten (10) hours per day at the straight time rate of pay with all hours in excess of ten (10) hours in any one day to be paid at the applicable overtime rate. If the Employer elects to work from Monday through Thursday and is stopped due to circumstances beyond his control, he shall have the option to work Friday or Saturday at the straight time rate of pay to complete his forty (40) hours. If an Employer is prohibited from working on a holiday, that Employer may work the following Friday or Saturday at the straight time rate. Overtime will be at one and one-half (1½) times the regular rate. If workmen are required to work the enumerated holidays or days observed as such, or Sundays, they shall receive double (2) the regular rate of pay for such work.

**REPLACEMENT PAGE
BOONE COUNTY
OVERTIME SCHEDULE - HEAVY CONSTRUCTION**

NO. 23: Means the regular workweek shall start on Monday and end on Friday, except where the Employer elects to work Monday through Thursday, (10) hours per day. All work over ten (10) hours in a day or forty (40) hours in a week shall be at the overtime rate of one and one-half (1½) times the regular hourly rate. The regular workday shall be either eight (8) or ten (10) hours. If a job can't work forty (40) hours Monday through Friday because of inclement weather or other conditions beyond the control of the Employer, Friday or Saturday may be worked as a make-up day at straight time (if working 4-10's). Saturday may be worked as a make-up day at straight time (if working 5-8's). An Employer, who is working a four (4) ten (10) hour day work schedule may use Friday as a make-up day when a workday is lost due to a holiday. A workday is to begin at the option of the Employer but not later than 11:00 a.m. except when inclement weather, requirements of the owner or other conditions beyond the reasonable control of the Employer prevent work. Except as worked as a make-up day, time on Saturday shall be worked at one and one-half (1½) times the regular rate. Work performed on Sunday shall be paid at two (2) times the regular rate. Work performed on recognized holidays or days observed as such, shall also be paid at the double (2) time rate of pay. For all overtime hours worked during the week or on Saturday \$14.55 of the fringe benefits portion of the prevailing wage shall be paid at time and one-half (1½). For all overtime hours worked on Sundays or recognized holidays \$14.55 of the fringe benefits portion of the prevailing wage shall be paid double time. The remaining \$.50 of the fringe benefit portion of the prevailing wage shall be paid at straight time.

NO. 25: Means a regular work week of forty (40) hours, starting on Monday and ending on Friday. The regular work day shall be either eight (8) or ten (10) hours. If a crew is prevented from working forty (40) hours Monday through Friday, or any part thereof by reason of inclement weather, Saturday or any part thereof maybe worked as a make-up day at the straight time rate. Employees who are part of a regular crew on a make-up day, notwithstanding the fact that they may not have been employed the entire week, shall work Saturday at the straight time rate. A work day is to begin between 6:00 a.m. and 9:00 a.m. However, the project starting time maybe advanced or delayed if mutually agreed to by the interest parties. All hours worked on recognized holidays, or days observed as such, double (2) time shall be paid.

NO. 28: Means a regular work week of forty (40) hours will start on Monday and end on Friday. The regular work day shall be either eight (8) or ten (10) hours. If a crew is prevented from working forty (40) hours Monday through Friday, or any part thereof by reason of inclement weather, Saturday or any part thereof may be worked as a make-up day at the straight time rate. Employees who are part of a regular crew on a make-up day, notwithstanding the fact that they may not have been employed the entire week, shall work Saturday at the straight time rate. A workday is to begin between 6:00 a.m. and 9:00 a.m. However, the project starting time may be advanced or delayed if mutually agreed to by the interest parties. For all time worked on recognized holidays, or days observed as such, double (2) time shall be paid.

NO. 32: Means the overtime rate shall be time and one-half the regular rate for work over forty (40) hours per week. Sundays and Holidays shall be paid at double the straight time rate.

**BOONE COUNTY
HOLIDAY SCHEDULE – HEAVY CONSTRUCTION**

NO. 4: All work performed on New Year's Day, Memorial Day, Independence Day, Labor Day, Thanksgiving Day, Christmas Day, or observed as such, shall be paid at the double time rate of pay. When a Holiday falls on a Sunday, Monday shall be observed. No work shall be performed on Labor Day, except in case of jeopardy to life or property. This is applied to protect Labor Day.

NO. 5: The following days are recognized as holidays: New Year's Day, Memorial Day, Fourth of July, Labor Day, Thanksgiving Day and Christmas Day. If a holiday falls on a Sunday, it shall be observed on the following Monday. If a holiday falls on a Saturday, it shall be observed on the preceding Friday. No work shall be performed on Labor Day except in case of jeopardy to work under construction. This rule is applied to protect Labor Day. When a holiday falls during the normal work week, Monday through Friday, it shall be counted as eight (8) hours toward a forty (40) hour week; however, no reimbursement for this eight (8) hours is to be paid the workman unless worked. If workmen are required to work the above recognized holidays or days observed as such, or Sundays, they shall receive double (2) the regular rate of pay for such work. The above shall apply to the four 10's Monday through Friday work week. The ten (10) hours shall be applied to the forty (40) hour work week.

NO. 12: All work performed on New Year's Day, Memorial Day, Fourth of July, Labor Day, Veteran's Day, Thanksgiving Day, Christmas Day, or days celebrated as such, shall be paid at the double time rate of pay. When one of the foregoing holidays falls on Sunday, it shall be celebrated on the following Monday. When one of the foregoing holidays falls on Saturday, it shall be celebrated on the Friday before the holiday.

NO. 16: The following days are recognized as holidays: New Year's Day, Memorial Day, Fourth of July, Labor Day, Thanksgiving Day and Christmas Day. If a holiday falls on Sunday, it shall be observed on the following Monday. If a holiday falls on Saturday, it shall be observed on the preceding Friday. No work shall be performed on Labor Day except in case of jeopardy to work under construction. This rule is applied to protect Labor Day. When a holiday falls during the normal work week, Monday through Friday, it shall be counted as eight (8) hours toward the forty (40) hour week; however, no reimbursement for this eight (8) hours is to be paid to the worker unless worked. If workers are required to work the above recognized holidays or days observed as such, they shall receive double (2) the regular rate of pay for such work.

NO. 21: The following days are recognized as holidays: New Year's Day, Memorial Day, Independence Day, Labor Day, Thanksgiving Day and Christmas Day. If a holiday falls on a Sunday, it shall be observed on the following Monday. No work shall be performed on Labor Day except in case of jeopardy to work under construction. This rule is applied to protect Labor Day. When a holiday falls during the normal work week, Monday through Friday, it shall be counted as eight (8) hours toward the forty (40) hour week; however, no reimbursement for this eight (8) hours is to be paid the workman unless worked. An Employer working a four (4) day, ten (10) hour schedule may use Friday as a make-up day when an observed holiday occurs during the work week. Employees have the option to work that make-up day. If workmen are required to work the above enumerated holidays, or days observed as such, they shall receive double (2) the regular rate of pay for such work.

NO. 27: The following days are recognized as holidays: New Year's Day, Memorial Day, Independence Day, Labor Day, Thanksgiving Day and Christmas Day. If a holiday falls on a Sunday, it shall be observed on the following Monday. No work shall be performed on Labor Day except in case of jeopardy to work under construction. This rule is applied to protect Labor Day. When a holiday falls during the normal work week, Monday through Friday, it shall be counted as eight (8) hours toward the forty (40) hour week; however, no reimbursement for this eight (8) hours is to be paid the workmen unless worked. An Employer working a four (4) day, ten (10) hour schedule may use Friday as a make up day when an observed holiday occurs during the work week. Employees have the option to work that make up day. If workmen are required to work the above enumerated holidays, or days observed as such, they shall receive double (2) the regular rate of pay for such work.

NO. 31: All work performed on New Year's Day, Presidents' Day, Veterans' Day, Good Friday, Decoration Day, Fourth of July, Labor Day, Christmas Eve Day, Christmas Day, Thanksgiving Day and Day after Thanksgiving or days celebrated for the same.